

Einzelkontakt (Stift), VPE 100 Stück
Single contact (Male), PU 100 pieces

Abbildung / Figure

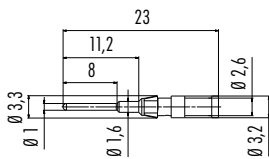

Maßzeichnung / Drawing



Bestell-Daten / Order Data

| Für Leiterquerschnitt For wire gauge | AWG AWG | Bestell-Nr. Ordering-No. |
|---|------------|-----------------------------|
| 0,14 mm ² – 0,34 mm ² | 26–22 | 61 1224 146 |
| 0,34 mm ² – 0,5 mm ² | 22–20 | 61 1154 146 |
| 0,75 mm ² – 1,0 mm ² | 18–16 | 61 1225 146 |
| 1,0 mm ² – 1,5 mm ² | 16 | 61 1226 146 |

Crimpzange für gedrehte Crimpkontakte
Crimping tool for turned crimp contacts

Abbildung / Figure



Bestell-Daten / Order Data

| Bestell-Nr. Ordering-No. |
|-----------------------------|
| 66 0003 001 |

Einzelkontakt (Buchse), VPE 100 Stück
Single contact (Female), PU 100 pieces

Abbildung / Figure



Maßzeichnung / Drawing

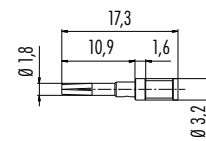

Bestell-Daten / Order Data

| Für Leiterquerschnitt For wire gauge | AWG AWG | Bestell-Nr. Ordering-No. |
|---|------------|-----------------------------|
| 0,14 mm ² – 0,34 mm ² | 26–22 | 61 1227 146 |
| 0,34 mm ² – 0,5 mm ² | 22–20 | 61 1155 146 |
| 0,75 mm ² – 1,0 mm ² | 18–16 | 61 1228 146 |
| 1,0 mm ² – 1,5 mm ² | 16 | 61 1229 146 |

Lösewerkzeug für Kontakte
Extraction tool for contacts

Abbildung / Figure



Bestell-Daten / Order Data

| Bestell-Nr. Ordering-No. |
|-----------------------------|
| 66 0004 001 |

Schutzkappe für Kabelstecker, IP67

Protection cap for male cable connector, IP67

Abbildung / Figure



Maßzeichnung / Drawing

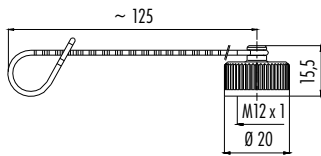

Bestell-Daten / Order Data

Bestell-Nr.
Ordering-No.

08 2424 010 000

Schutzkappe für Kabeldose, IP67

Protection cap for female cable connector, IP67



Maßzeichnung / Drawing

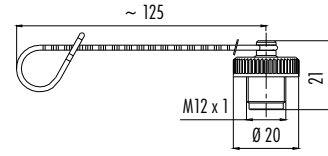

Bestell-Daten / Order Data

Bestell-Nr.
Ordering-No.

08 2425 010 000

Schutzkappe für Flanschstecker, IP67

Protection cap for male panel mount connector, IP67

Abbildung / Figure



Maßzeichnung / Drawing

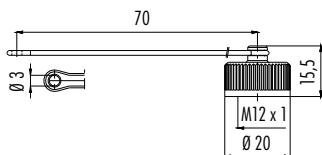

Bestell-Daten / Order Data

Bestell-Nr.
Ordering-No.

08 2615 000 000

Schutzkappe für Flanschdose, IP67

Protection cap for female panel mount connector, IP67



Maßzeichnung / Drawing

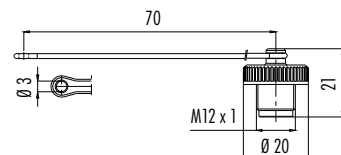

Bestell-Daten / Order Data

Bestell-Nr.
Ordering-No.

08 2616 000 000

Schutzkappe für Flanschstecker, IP67
Protection cap for male panel mount connector, IP67

Abbildung / Figure



Maßzeichnung / Drawing

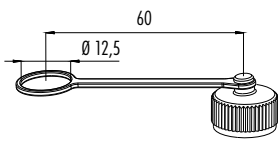

Bestell-Daten / Order Data

Bestell-Nr.
Ordering-No.

08 2676 000 000

Schutzkappe für Flanschdose, IP67
Protection cap for female panel mount connector, IP67

Abbildung / Figure



Maßzeichnung / Drawing

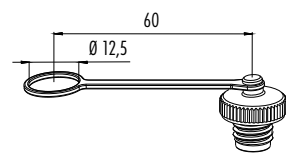

Bestell-Daten / Order Data

Bestell-Nr.
Ordering-No.

08 2677 000 000

Schutzkappe für Flanschstecker, IP67, Frontmontage
Protection cap for male panel mount connector, IP67, front fastened

Abbildung / Figure



Maßzeichnung / Drawing

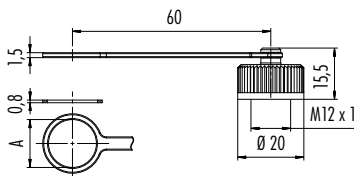

Bestell-Daten / Order Data

| Maß A Measure A | Bestell-Nr. Ordering-No. |
|--------------------|-----------------------------|
| 11 mm | 08 2989 000 000 |
| 14,5 mm | 08 2990 000 000 |

Schutzkappe für Flanschdose, IP67, Frontmontage
Protection cap for female panel mount connector, IP67, front fastened

Abbildung / Figure



Maßzeichnung / Drawing

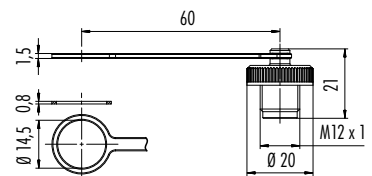

Bestell-Daten / Order Data

Bestell-Nr.
Ordering-No.

08 2991 000 000

Schutzkappe für Dose, IP67

Protection cap for female connector, IP67

Abbildung / Figure



Maßzeichnung / Drawing

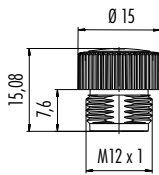

Bestell-Daten / Order Data

| Bestell-Nr. Ordering-No. |
|-----------------------------|
| 08 2769 000 000 |

Sechskantmutter für Befestigungsgewinde
Hexagonal nut for fixing thread

Abbildung / Figure



Maßzeichnung / Drawing

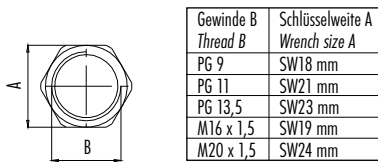

Bestell-Daten / Order Data

| Gewinde B Thread B | Schlüsselweite A Wrench size A | Bestell-Nr. Ordering-No. | ■ A- ■ B-, D-/X-Kodierung/Coding |
|-----------------------|-----------------------------------|-----------------------------|--|
| PG 9 | SW18 mm | 16 0402 001 | ■ A- ■ B-, D-/X-Kodierung/Coding |
| PG 11 | SW21 mm | 16 0403 001 | ■ A- ■ B-, D-/X-Kodierung/Coding |
| PG 13,5 | SW23 mm | 16 0401 001 | ■ A- ■ B-, D-/X-Kodierung/Coding |
| M16 x 1,5 | SW19 mm | 16 0916 001 | ■ A- ■ B-, D-/X-, S-, T-Kodierung/Coding |
| M20 x 1,5 | SW24 mm | 16 0917 001 | ■ A- ■ B-, D-/X-, S-, T-Kodierung/Coding |

Blindverschraubung PG 9/M16 x 1,5

Dummy plug PG 9/M16 x 1,5



Maßzeichnung / Drawing

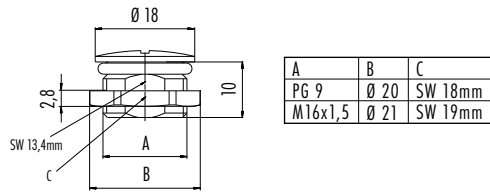

| Gewinde Thread | Bestell-Nr. Ordering-No. | ■ A-Kodierung/Coding ■ B-, D-Kodierung/Coding |
|-------------------|-----------------------------|---|
| PG 9 | 08 3128 000 000 | ■ A-Kodierung/Coding ■ B-, D-Kodierung/Coding |
| M16 x 1,5 | 08 3129 000 000 | ■ A-Kodierung/Coding ■ B-, D-/X-, S-, T-Kodierung/Coding |

Ringmutter für Befestigungsgewinde
Ring nut for fixing thread

Abbildung / Figure



Maßzeichnung / Drawing

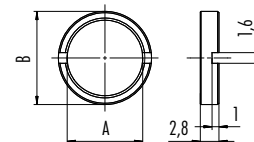

| Gewinde A Thread A | Durchmesser B Diameter B | Bestell-Nr. Ordering-No. |
|-----------------------|-----------------------------|-----------------------------|
| PG 9 | 18 mm | 01 5322 001 |
| M12 x 1 | 14 mm | 01 5325 001 |
| M16 x 1,5 | 18 mm | 01 5244 001 |

Schirmblech für Flanschsteckverbinder, von hinten verschraubbar
Shielding sheet for panel mount connectors, fastened from back side

Abbildung / Figure



Maßzeichnung / Drawing

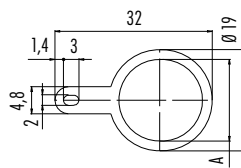

Bestell-Daten / Order Data

| Gewinde Thread | Maß A Measure A | Bestell-Nr. Ordering-No. | |
|-------------------|--------------------|-----------------------------|---|
| PG 9 | 15,3 mm | 04 0734 124 | ■ A-Kodierung/Coding ■ B-, D-/X-Kodierung/Coding |
| M16 x 1,5 | 16,1 mm | 04 0735 124 | ■ A-Kodierung/Coding ■ B-, D-/X-, S-, T-Kodierung/Coding |

Montageschlüssel für Ringmutter
Mounting spanner for ring nut

Abbildung / Figure



Maßzeichnung / Drawing

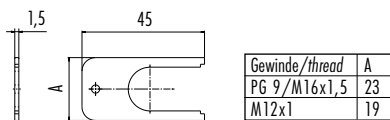

Bestell-Daten / Order Data

| Gewinde A Thread A | Bestell-Nr. Ordering-No. |
|-----------------------|-----------------------------|
| PG 9/M16 x 1,5 | 07 0084 000 |
| M12 x 1 | 07 0083 000 |

Flachdichtung für Befestigungsgewinde PG 9/M16 x 1,5
Flat sealing for fixing thread PG 9/M16 x 1,5

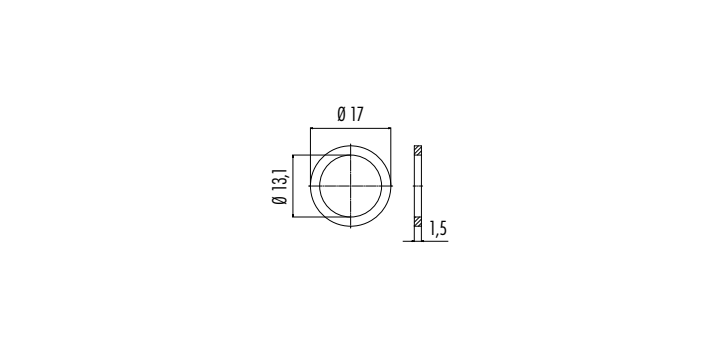

| Bestell-Nr. Ordering-No. |
|-----------------------------|
| 16 1125 071 |

Hülse gegen versehentliches Trennen unter Last
Sleeve against inadvertent unmating under load



| Bestell-Nr. Ordering-No. |
|-----------------------------|
| 16 0977 000 |

Schlauchverschraubung
Screwing for tube

Abbildung / Figure



Maßzeichnung / Drawing

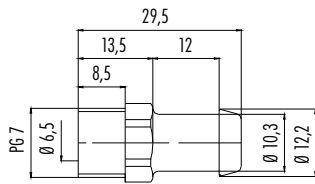

Bestell-Daten / Order Data

Bestell-Nr.
Ordering-No.

02 0273 000

Dichtung für Kunststoff-Vierkantflanschstecker,
Sealing for square flange, plastic version

Abbildung / Figure



Maßzeichnung / Drawing

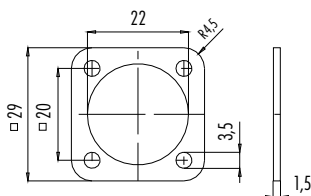

Bestell-Daten / Order Data

Bestell-Nr.
Ordering-No.

16 8091 000

Leiterplatte mit einer LED grün/gelb, zum Einbau in Kabelsteckverbinder, Schraubklemm
PCB with two LEDs green/yellow, for cable connectors, screw termination

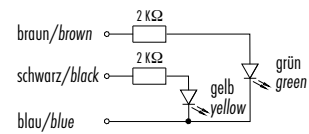
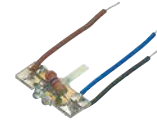

Bestell-Nr.
Ordering-No.

08 0462 000 000

Dichtung für Metall-Vierkantflanschstecker,
Sealing for square flange, metal version

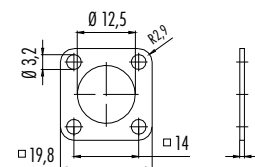

Bestell-Nr.
Ordering-No.

16 0959 000

Schlüssel mit Drehmomentbegrenzung Sechskant SW 13, 0,6 Nm
Hexagon torque spanner SW 13, 0,6 Nm

Abbildung / Figure



Maßzeichnung / Drawing

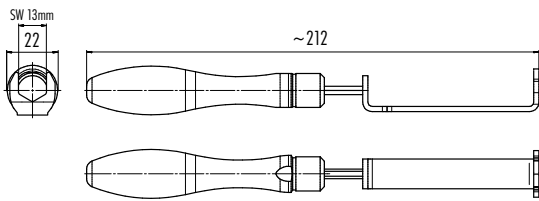

Bestell-Daten / Order Data

Bestell-Nr.
Ordering-No.

07 0086 000

Schlüssel mit Drehmomentbegrenzung, Sechskant SW 18, 0,6 Nm
Hexagon torque spanner SW 18, 0,6 Nm

Abbildung / Figure



Maßzeichnung / Drawing

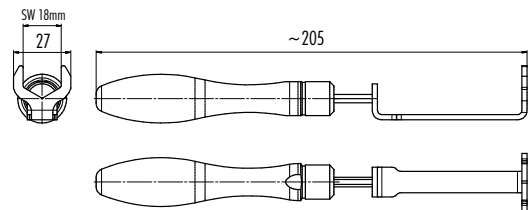

Bestell-Daten / Order Data

Bestell-Nr.
Ordering-No.

07 0079 000

Montageschlüssel zur Montage von M12 Verriegelungsring
Mounting tool for M12 locking ring

Abbildung / Figure



Maßzeichnung / Drawing

Bestell-Daten / Order Data

Bestell-Nr.
Ordering-No.

07 0078 000