

# Power / M23

Power / M23



## M23

## M23

### Kabelsteckverbinder

- Schraubverriegelung M23
- 6 – 19-polig
- Schutzart IP67 <sup>1)</sup>
- Lötanschluss
- Durchmesser 26 mm
- Schirmbare Ausführungen

### Flanschsteckverbinder

- Schraubverriegelung M23
- 6 – 19-polig
- Schutzart IP67 <sup>1)</sup>
- Lötanschluss
- Durchmesser 26 mm
- Kantenlänge 25 mm

**Crimpvarianten auf Anfrage**

### Cable Connectors

- Screw termination M23
- 6 – 19 contacts
- Degree of protection IP67 <sup>1)</sup>
- Solder termination
- Diameter 26 mm
- Shieldable versions

### Panel Mount Connectors

- Screw termination M23
- 6 – 19 contacts
- Degree of protection IP67 <sup>1)</sup>
- Solder termination
- Diameter 26 mm
- Feed size 25 mm

**Crimp versions on request**

<sup>1)</sup>Erläuterung der Schutzarten siehe technische Informationen./ <sup>1)</sup>Explanation of protection standards see technical information.

**Kabelstecker**  
Male cable connector

Abbildung / Figure



**Kabelstecker, schirmbar**  
Male cable connector, shieldable



Erdungshülsen mit Dichtung müssen separat bestellt werden. Siehe Seite 296.  
Earth sleeves with seals have to be ordered separately. See page 296.

Maßzeichnung / Drawing

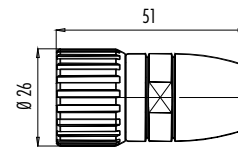
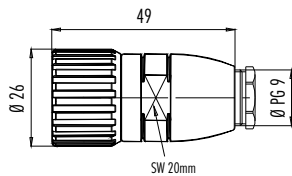

Bestell-Daten / Order Data

Polzahl Contacts	Kabeldurchlass Cable outlet	Bestell-Nr. (rechtsdrehend) Ordering-No. (clockwise)
6	6–10 mm	99 4635 00 06
9	6–10 mm	99 4601 00 09
12	6–10 mm	99 4605 00 12
16	6–10 mm	99 4609 00 16
19	6–10 mm	99 4631 00 19

Polzahl Contacts	Kabeldurchlass Cable outlet	Bestell-Nr. (rechtsdrehend) Ordering-No. (clockwise)
6	6–10 mm	99 4645 00 06
9	6–10 mm	99 4619 00 09
12	6–10 mm	99 4621 00 12
16	6–10 mm	99 4623 00 16
19	6–10 mm	99 4643 00 19

Technische Daten / Specifications

Polzahl	6	9	12	16	19	Number of contacts
Steckverbinder Verriegelung	schrauben/screw					Connector locking system
Anschlussart	löten/solder					Termination
Anschlussquerschnitt	2,5 mm <sup>2</sup> (AWG 14)	8x1,5 mm <sup>2</sup> (AWG 16)/1x2,5 mm <sup>2</sup> (AWG 14)	1,0 mm <sup>2</sup> (AWG 18)		16x1 mm <sup>2</sup> (AWG 18)/3x1,5 mm <sup>2</sup> (AWG 16)	Wire gauge
Kabeldurchlass	6–10 mm					Cable outlet
Schutzart	IP67					Degree of protection
Mechanische Lebensdauer	> 50 Steckzyklen/> 50 mating cycles					Mechanical operation
Obere Grenztemperatur	+ 125 °C					Upper temperature
Untere Grenztemperatur	– 20 °C					Lower temperature
Bemessungsspannung	48 V					Rated voltage
Bemessungs-Stoßspannung	2500 V		1500 V			Rated impulse voltage
Verschmutzungsgrad	3					Pollution degree
Überspannungskategorie	II					Overvoltage categorie
Isolierstoffgruppe	III					Material group
Bemessungsstrom (40 °C)	20 A	8 x 8 A/1 x 20 A	8 A		16 x 8 A/3 x 10 A	Rated current (40 °C)
Durchgangswiderstand	≤ 3 mΩ					Contact resistance
Material Kontakt	CuZn (Messing/brass)					Material of contact
Kontaktoberfläche	Au (Gold/gold)					Contact plating
Material Kontaktkörper	PBT/PA66					Material of contact body
Material Gehäuse	CuZn (Messing vernickelt/brass nickel plated)					Material of housing

**Kupplungsstecker**  
Male coupling connector

Abbildung / Figure



**Kupplungsstecker, schirmbar**  
Male coupling connector, shieldable



Erdungshülsen mit Dichtung müssen separat bestellt werden. Siehe Seite 296.  
Earth sleeves with seals have to be ordered separately. See page 296.

Maßzeichnung / Drawing

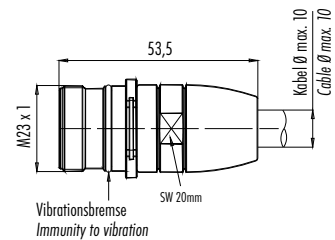
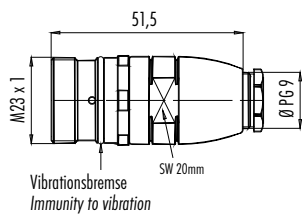

Bestell-Daten / Order Data

Polzahl Contacts	Kabeldurchlass Cable outlet	Bestell-Nr. (rechtsdrehend) Ordering-No. (clockwise)
6	6–10 mm	99 4641 00 06
9	6–10 mm	99 4613 00 09
12	6–10 mm	99 4615 00 12
19	6–10 mm	99 4639 00 19

Polzahl Contacts	Kabeldurchlass Cable outlet	Bestell-Nr. (rechtsdrehend) Ordering-No. (clockwise)
6	6–10 mm	99 4649 00 06
9	6–10 mm	99 4625 00 09
12	6–10 mm	99 4627 00 12
16	6–10 mm	99 4629 00 16
19	6–10 mm	99 4647 00 19

Technische Daten / Specifications

Polzahl	6	9	12	16	19	Number of contacts
Steckverbinder Verriegelung	schrauben/screw					Connector locking system
Anschlussart	löten/solder					Termination
Anschlussquerschnitt	2,5 mm <sup>2</sup> (AWG 14)	8x1,5 mm <sup>2</sup> (AWG 16)/1x2,5 mm <sup>2</sup> (AWG 14)	1,0 mm <sup>2</sup> (AWG 18)		16x1 mm <sup>2</sup> (AWG 18)/3x1,5 mm <sup>2</sup> (AWG 16)	Wire gauge
Kabeldurchlass	6–10 mm					Cable outlet
Schutzart	IP67					Degree of protection
Mechanische Lebensdauer	> 50 Steckzyklen/> 50 mating cycles					Mechanical operation
Obere Grenztemperatur	+ 125 °C					Upper temperature
Untere Grenztemperatur	– 20 °C					Lower temperature
Bemessungsspannung	48 V					Rated voltage
Bemessungs-Stoßspannung	2500 V		1500 V			Rated impulse voltage
Verschmutzungsgrad	3					Pollution degree
Überspannungskategorie	II					Overvoltage categorie
Isolierstoffgruppe	III					Material group
Bemessungsstrom (40°C)	20 A	8 x 8 A/1 x 20 A		8 A	16 x 8 A/3 x 10 A	Rated current (40 °C)
Durchgangswiderstand	≤ 3 mΩ					Contact resistance
Material Kontakt	CuZn (Messing/brass)					Material of contact
Kontaktfläche	Au (Gold/gold)					Contact plating
Material Kontaktkörper	PBT/PA66					Material of contact body
Material Gehäuse	CuZn (Messing vernickelt/brass nickel plated)					Material of housing

Winkelstecker  
Male angled connector

Abbildung / Figure



Maßzeichnung / Drawing

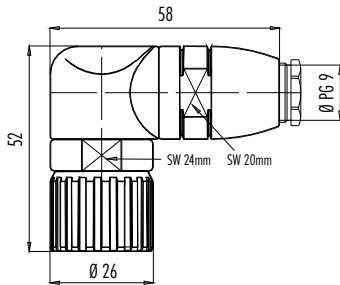

Bestell-Daten / Order Data

Polzahl Contacts	Kabeldurchlass Cable outlet	Bestell-Nr. (rechtsdrehend) Ordering-No. (clockwise)
6	6–10 mm	99 4635 70 06
9	6–10 mm	99 4601 70 09
12	6–10 mm	99 4605 70 12
16	6–10 mm	99 4609 70 16
19	6–10 mm	99 4631 70 19

Technische Daten / Specifications

Polzahl	6	9	12	16	19	Number of contacts
Steckverbinder Verriegelung	schrauben/screw					Connector locking system
Anschlussart	löten/solder					Termination
Anschlussquerschnitt	2,5 mm <sup>2</sup> (AWG 14)	8x1,5 mm <sup>2</sup> (AWG 16)/1x2,5 mm <sup>2</sup> (AWG 14)	1,0 mm <sup>2</sup> (AWG 18)	16x1 mm <sup>2</sup> (AWG 18)/3x1,5 mm <sup>2</sup> (AWG 16)		Wire gauge
Kabeldurchlass	6–10 mm					Cable outlet
Schutzart	IP67					Degree of protection
Mechanische Lebensdauer	> 50 Steckzyklen/> 50 mating cycles					Mechanical operation
Obere Grenztemperatur	+ 125 °C					Upper temperature
Untere Grenztemperatur	– 20 °C					Lower temperature
Bemessungsspannung	48 V					Rated voltage
Bemessungs-Stoßspannung	2500 V		1500 V			Rated impulse voltage
Verschmutzungsgrad	3					Pollution degree
Überspannungskategorie	II					Overvoltage categorie
Isolierstoffgruppe	III					Material group
Bemessungsstrom (40°C)	20 A	8 x 8 A/1 x 20 A	8 A	16 x 8 A/3 x 10 A		Rated current (40 °C)
Durchgangswiderstand	≤ 3 mΩ					Contact resistance
Material Kontakt	CuZn (Messing/brass)					Material of contact
Kontaktoberfläche	Au (Gold/gold)					Contact plating
Material Kontaktkörper	PBT/PA66					Material of contact body
Material Gehäuse	CuZn (Messing vernickelt/brass nickel plated)					Material of housing

**Kabeldose**  
Female cable connector

Abbildung / Figure



**Kabeldose, schirmbar**  
Female cable connector, shieldable



Erdungshülsen mit Dichtung müssen separat bestellt werden. Siehe Seite 296.  
Earth sleeves with seals have to be ordered separately. See page 296.

Maßzeichnung / Drawing

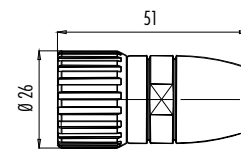
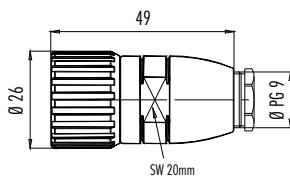

Bestell-Daten / Order Data

Polzahl Contacts	Kabeldurchlass Cable outlet	Bestell-Nr. (rechtsdrehend) Ordering-No. (clockwise)
6	6–10 mm	99 4636 00 06
9	6–10 mm	99 4602 00 09
12	6–10 mm	99 4606 00 12
16	6–10 mm	99 4610 00 16
19	6–10 mm	99 4632 00 19

Polzahl Contacts	Kabeldurchlass Cable outlet	Bestell-Nr. (rechtsdrehend) Ordering-No. (clockwise)
6	6–10 mm	99 4646 00 06
9	6–10 mm	99 4620 00 09
12	6–10 mm	99 4622 00 12
16	6–10 mm	99 4624 00 16
19	6–10 mm	99 4644 00 19

Technische Daten / Specifications

Polzahl	6	9	12	16	19	Number of contacts
Steckverbinder Verriegelung	schrauben/screw					Connector locking system
Anschlussart	löten/solder					Termination
Anschlussquerschnitt	2,5 mm <sup>2</sup> (AWG 14)	8x1,5 mm <sup>2</sup> (AWG 16)/1x2,5 mm <sup>2</sup> (AWG 14)	1,0 mm <sup>2</sup> (AWG 18)		16x1 mm <sup>2</sup> (AWG 18)/3x1,5 mm <sup>2</sup> (AWG 16)	Wire gauge
Kabeldurchlass	6–10 mm					Cable outlet
Schutzart	IP67					Degree of protection
Mechanische Lebensdauer	> 50 Steckzyklen/> 50 mating cycles					Mechanical operation
Obere Grenztemperatur	+ 125 °C					Upper temperature
Untere Grenztemperatur	– 20 °C					Lower temperature
Bemessungsspannung	48 V					Rated voltage
Bemessungs-Stoßspannung	2500 V		1500 V			Rated impulse voltage
Verschmutzungsgrad	3					Pollution degree
Überspannungskategorie	II					Overvoltage categorie
Isolierstoffgruppe	III					Material group
Bemessungsstrom (40°C)	20 A	8 x 8 A/1 x 20 A		8 A	16 x 8 A/3 x 10 A	Rated current (40 °C)
Durchgangswiderstand	≤ 3 mΩ					Contact resistance
Material Kontakt	CuSn (Bronze/bronze)					Material of contact
Kontaktoberfläche	Au (Gold/gold)					Contact plating
Material Kontaktkörper	PBT/PA66					Material of contact body
Material Gehäuse	CuZn (Messing vernickelt/brass nickel plated)					Material of housing

**Kupplungsdose**  
Female coupling connector

Abbildung / Figure



**Kupplungsdose, schirmbar**  
Female coupling connector, shieldable



Erdungshülsen mit Dichtung müssen separat bestellt werden. Siehe Seite 296.  
Earth sleeves with seals have to be ordered separately. See page 296.

Maßzeichnung / Drawing

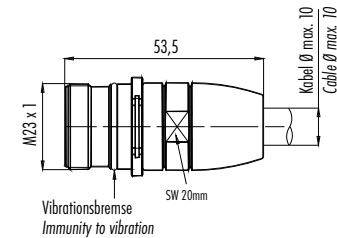
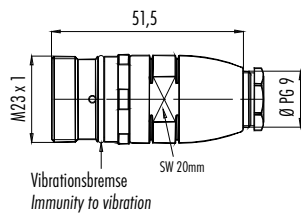

Bestell-Daten / Order Data

Polzahl Contacts	Kabeldurchlass Cable outlet	Bestell-Nr. (rechtsdrehend) Ordering-No. (clockwise)
6	6–10 mm	99 4642 00 06
9	6–10 mm	99 4614 00 09
12	6–10 mm	99 4616 00 12
16	6–10 mm	99 4618 00 16
19	6–10 mm	99 4640 00 19

Polzahl Contacts	Kabeldurchlass Cable outlet	Bestell-Nr. (rechtsdrehend) Ordering-No. (clockwise)
6	6–10 mm	99 4650 00 06
9	6–10 mm	99 4626 00 09
12	6–10 mm	99 4628 00 12
16	6–10 mm	99 4630 00 16
19	6–10 mm	99 4648 00 19

Technische Daten / Specifications

Polzahl	6	9	12	16	19	Number of contacts
Steckverbinder Verriegelung	schrauben/screw					Connector locking system
Anschlussart	löten/solder					Termination
Anschlussquerschnitt	2,5 mm <sup>2</sup> (AWG 14)	8x1,5 mm <sup>2</sup> (AWG 16)/1x2,5 mm <sup>2</sup> (AWG 14)	1,0 mm <sup>2</sup> (AWG 18)	16x1 mm <sup>2</sup> (AWG 18)/3x1,5 mm <sup>2</sup> (AWG 16)		Wire gauge
Kabeldurchlass	6–10 mm					Cable outlet
Schutzart	IP67					Degree of protection
Mechanische Lebensdauer	> 50 Steckzyklen/> 50 mating cycles					Mechanical operation
Obere Grenztemperatur	+ 125 °C					Upper temperature
Untere Grenztemperatur	– 20 °C					Lower temperature
Bemessungsspannung	48 V					Rated voltage
Bemessungs-Stoßspannung	2500 V		1500 V			Rated impulse voltage
Verschmutzungsgrad	3					Pollution degree
Überspannungskategorie	II					Overvoltage categorie
Isolierstoffgruppe	III					Material group
Bemessungsstrom (40 °C)	20 A	8 x 8 A/1 x 20 A	8 A	16 x 8 A/3 x 10 A		Rated current (40 °C)
Durchgangswiderstand	≤ 3 mΩ					Contact resistance
Material Kontakt	CuSn (Bronze/bronze)					Material of contact
Kontaktoberfläche	Au (Gold/gold)					Contact plating
Material Kontaktkörper	PBT/PA66					Material of contact body
Material Gehäuse	CuZn (Messing vernickelt/brass nickel plated)					Material of housing

**Winkeldose**  
Female angled connector

Abbildung / Figure



Maßzeichnung / Drawing

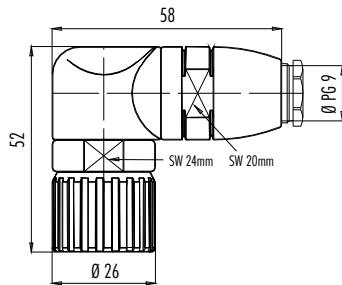

Bestell-Daten / Order Data

Polzahl Contacts	Kabeldurchlass Cable outlet	Bestell-Nr. (rechtsdrehend) Ordering-No. (clockwise)
6	6–10 mm	99 4636 70 06
9	6–10 mm	99 4602 70 09
12	6–10 mm	99 4606 70 12
16	6–10 mm	99 4610 70 16
19	6–10 mm	99 4632 70 19

Technische Daten / Specifications

Polzahl	6	9	12	16	19	Number of contacts
Steckverbinder Verriegelung	schrauben/screw					Connector locking system
Anschlussart	löten/solder					Termination
Anschlussquerschnitt	2,5 mm <sup>2</sup> (AWG 14)	8x1,5 mm <sup>2</sup> (AWG 16)/1x2,5 mm <sup>2</sup> (AWG 14)	1,0 mm <sup>2</sup> (AWG 18)		16x1 mm <sup>2</sup> (AWG 18)/3x1,5 mm <sup>2</sup> (AWG 16)	Wire gauge
Kabeldurchlass	6–10 mm					Cable outlet
Schutzart	IP67					Degree of protection
Mechanische Lebensdauer	> 50 Steckzyklen/> 50 mating cycles					Mechanical operation
Obere Grenztemperatur	+ 125 °C					Upper temperature
Untere Grenztemperatur	– 20 °C					Lower temperature
Bemessungsspannung	48 V					Rated voltage
Bemessungs-Stoßspannung	2500 V		1500 V			Rated impulse voltage
Verschmutzungsgrad	3					Pollution degree
Überspannungskategorie	II					Overvoltage categorie
Isolierstoffgruppe	III					Material group
Bemessungsstrom (40°C)	20 A	8 x 8 A/1 x 20 A		8 A	16 x 8 A/3 x 10 A	Rated current (40 °C)
Durchgangswiderstand	≤ 3 mΩ					Contact resistance
Material Kontakt	CuSn (Bronze/bronze)					Material of contact
Kontaktoberfläche	Au (Gold/gold)					Contact plating
Material Kontaktkörper	PBT/PA66					Material of contact body
Material Gehäuse	CuZn (Messing vernickelt/brass nickel plated)					Material of housing



Montageanleitung  
Assembly instruction

Kabelsteckverbinder, gerade, ungeschirmt  
Straight cable connectors, unshielded

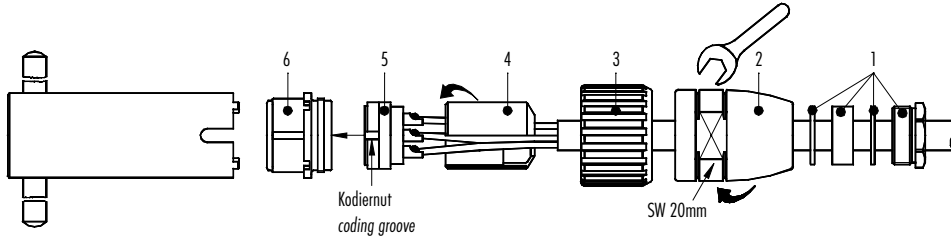

- Kabelverschraubung Pos. 1, Adapter Pos. 2 und Überwurfmutter Pos. 3 auf das Kabel schieben.
- Kabel-Außenmantel 20 mm abisolieren.
- Folie, Füller und innere Isolierungen abschneiden.
- Litzen 3,5 mm abisolieren, verdrehen und verzinnen.
- Litzen an Kontakte löten.
- Distanzhülse Pos. 4 einfügen.
- Einsatz Pos. 5 und Distanzhülse Pos. 4 in Einsatzring Pos. 6 einführen. Hierbei ist zu beachten, daß die gewünschte Kodiernut des Einsatzes Pos. 6 in den Kodiersteg eingeführt wird.
- Adapter Pos. 2 Festschrauben auf Anschlag.
- Kabelverschraubung Pos. 1 Festschrauben.

- Push the cable screw connection (1), adapter (2) and coupling nut (3) onto the cable.
- Strip the cable coating by 20 mm.
- Trim foil, filler and inner insulation.
- Strip the single wires by 3.5 mm, twist and tin.
- Solder the single wires to the contacts.
- Insert the distance shell (4).
- Guide the insert (5) and distance shell (4) into the insert ring (6), mind that the desired coding groove of the insert (6) is pushed into the coding bar.
- Screw the adapter (2) as tight as possible.
- Screw the cable gland (1) as tight as possible.

Anzugsdrehmoment für Klemmschraube Kontakteinsatz Pos. 5 mit Schraubkontakten beachten:

- max. 0,1 Nm für Schraubkontakte Steckdurchmesser 1 mm
- max. 0,2 Nm für Schraubkontakte Steckdurchmesser 2 mm

Please note: torque for clamping screw for contact insert (5) with screw contacts:

- max. 0.1 Nm for screw contacts with mating dia. 1 mm
- max. 0.2 Nm for screw contacts with mating dia. 2 mm

Kabelsteckverbinder, gerade, geschirmt  
Straight cable connectors, shielded

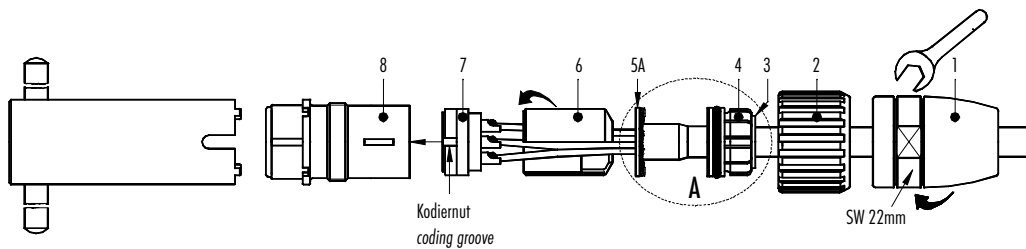

- Adapter Pos. 1, Überwurfmutter Pos. 2, Dichtelement Pos. 4 mit Dichtring Pos. 3 auf das Kabel schieben.
- Kabel-Außenmantel 23 mm abisolieren.
- Detail A: Schirmgeflecht 90° hochstellen, Schirmhülse Pos. 5A über die Folie bzw. Baumwollgeflecht jedoch unter das Schirmgeflecht mit drehender Bewegung schieben. Schirmgeflecht bündig mit Außendurchmesser Schirmhülse Pos. 5A abschneiden.
- Folie, Füller und innere Isolierungen abschneiden.
- Litzen 3,5 mm abisolieren, verdrehen und verzinnen.
- Litzen an Kontakte löten.
- Distanzhülse Pos. 6 einfügen.
- Einsatz Pos. 7 und Distanzhülse Pos. 6 in Einsatzhülse Pos. 8 einführen. Hierbei ist zu beachten, daß die gewünschte Kodiernut des Einsatzes Pos. 7 in den Kodiersteg eingeführt wird.
- Kabel mit Schirm- und Dichteinheit eindrücken.
- Adapter Pos. 1 Festschrauben auf Anschlag.

- Push the adapter (1), the coupling nut (2) and the sealing ring (4) with the gasket (3) onto the cable.
- Strip the cable coating by 23 mm.
- Detail A: Push back the shielding braid so it stands out at 90°. With a rotating motion, push the shielding braid (5A) over the foil or cotton braid and under the shielding braid. Cut the shielding braid and flush with the external diameter of the shielded sleeve (5A).
- Trim foil, filler and inner insulation.
- Strip the single wires by 3.5 mm, twist and tin.
- Solder the single wires to the contacts.
- Insert the distance shell (6).
- Guide the insert (7) and distance shell (6) into the insert sleeve (8), mind that the desired coding groove of the insert (7) is pushed into the coding bar.
- Press in the cable with the shield and sealing unit.
- Screw the adapter (1) as tight as possible.

Anzugsdrehmoment für Klemmschraube Kontakteinsatz Pos. 7 mit Schraubkontakten beachten:

- max. 0,1 Nm für Schraubkontakte Steckdurchmesser 1 mm
- max. 0,2 Nm für Schraubkontakte Steckdurchmesser 2 mm

Please note: torque for clamping screw for contact insert (7) with screw contacts:

- max. 0.1 Nm for screw contacts with mating dia. 1 mm
- max. 0.2 Nm for screw contacts with mating dia. 2 mm

Montageanleitung  
Assembly instruction

Winkelsteckverbinder, gerade, ungeschirmt  
Angled connectors, unshielded

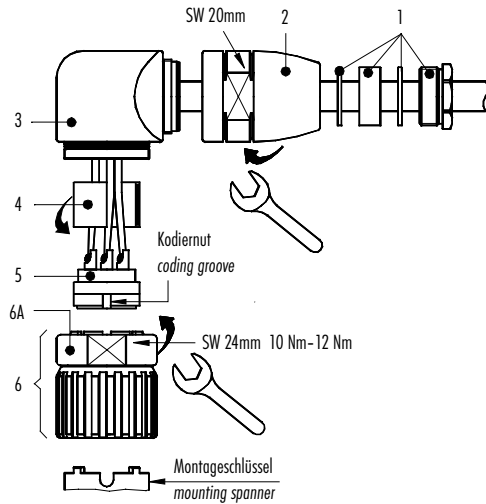

- Kabelverschraubung Pos. 1, Adapter Pos. 2 und Winkelkörper Pos. 3 auf das Kabel schieben.
- Kabel-Außenmantel 30 mm abisolieren.
- Folie, Füller und innere Isolierungen abschneiden.
- Litzen 3,5 mm abisolieren, verdrehen und verzinnen.
- Litzen an Kontakte löten.
- Distanzhülse Pos. 4 einfügen.
- Einsatz Pos. 5 und Distanzhülse Pos. 4 in Einheit Pos. 6 einfügen. Hierbei ist zu beachten, daß die gewünschte Kodiernut des Einsatzes Pos. 5 in den Kodiersteg eingeführt wird.
- Gesamte Einheit in Winkelkörper einführen (Achtung: acht Kodiernutmöglichkeiten) und mit Mutter Pos. 6A sichern (Anzugsdrehmoment: 10 Nm bis 12 Nm).
- Adapter Pos. 2 Festschrauben auf Anschlag.
- Kabelverschraubung Pos. 1 Festschrauben.

Anzugsdrehmoment für Klemmschraube Kontakteinsatz Pos. 5 mit Schraubkontakten beachten:

- max. 0,1 Nm für Schraubkontakte Steckdurchmesser 1 mm
- max. 0,2 Nm für Schraubkontakte Steckdurchmesser 2 mm

- Push the cable screw connection (1), adapter (2) and angled housing (3) onto the cable.
- Strip the cable coating by 30 mm.
- Trim foil, filler and inner insulation.
- Strip the single wires by 3.5 mm, twist and tin.
- Solder the single wires to the contacts.
- Insert the distance shell (4).
- Guide the insert (5) and distance shell (4) into the unit (6), mind that the desired coding groove of the insert (5) is pushed into the coding bar.
- Insert the entire unit into the angle housing (Attention: eight coding options) and secure with nut (6A) (torque: 10 Nm up to 12 Nm).
- Screw the adapter (2) as tight as possible.
- Screw the cable gland (1) as tight as possible.

Please note: torque for clamping screw for contact insert (5) with screw contacts:

- max. 0.1 Nm for screw contacts with mating dia. 1 mm
- max. 0.2 Nm for screw contacts with mating dia. 2 mm

**Flanschstecker, Zentralbefestigung, PG 13,5**  
Male panel mount connector, center fastened, PG 13,5

Abbildung / Figure



**Flanschstecker, Frontmontage**  
Male panel mount connector, front fastened



Maßzeichnung / Drawing

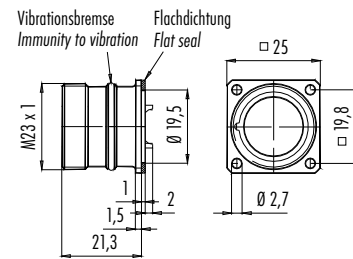
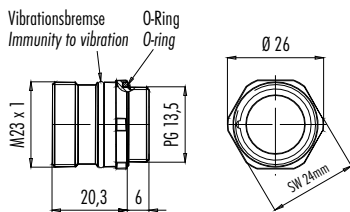

Bestell-Daten / Order Data

Polzahl Contacts	Bestell-Nr. (rechtsdrehend) Ordering-No. (clockwise)
6	99 4637 20 06
9	99 4603 20 09
12	99 4607 20 12
16	99 4611 20 16
19	99 4633 20 19

Polzahl Contacts	Bestell-Nr. (rechtsdrehend) Ordering-No. (clockwise)
6	99 4637 00 06
9	99 4603 00 09
12	99 4607 00 12
16	99 4611 00 16
19	99 4633 00 19

Technische Daten / Specifications

Polzahl	6	9	12	16	19	Number of contacts
Steckverbinder Verriegelung	schrauben/screw					Connector locking system
Anschlussart	löten/solder					Termination
Anschlussquerschnitt	2,5 mm <sup>2</sup> (AWG 14)	8x1,5 mm <sup>2</sup> (AWG 16)/1x2,5 mm <sup>2</sup> (AWG 14)	1,0 mm <sup>2</sup> (AWG 18)	16x1 mm <sup>2</sup> (AWG 18)/3x1,5 mm <sup>2</sup> (AWG 16)		Wire gauge
Kabeldurchlass	—					Cable outlet
Schutzart	IP67					Degree of protection
Mechanische Lebensdauer	> 50 Steckzyklen/> 50 mating cycles					Mechanical operation
Obere Grenztemperatur	+ 125 °C					Upper temperature
Untere Grenztemperatur	- 20 °C					Lower temperature
Bemessungsspannung	48 V					Rated voltage
Bemessungs-Stoßspannung	2500 V		1500 V			Rated impulse voltage
Verschmutzungsgrad	3					Pollution degree
Überspannungskategorie	II					Overvoltage categorie
Isolierstoffgruppe	III					Material group
Bemessungsstrom (40 °C)	20 A	8 x 8 A/1 x 20 A	8 A	16 x 8 A/3 x 10 A		Rated current (40 °C)
Durchgangswiderstand	≤ 3 mΩ					Contact resistance
Material Kontakt	CuZn (Messing/brass)					Material of contact
Kontaktoberfläche	Au (Gold/gold)					Contact plating
Material Kontaktkörper	PBT/PA66					Material of contact body
Material Gehäuse	Zink Druckguss vernickelt/zinc diecasting nickel plated					Material of housing

Flanschstecker, Rückwandmontage

Male panel mount connector, fastened from back side

Abbildung / Figure



Maßzeichnung / Drawing

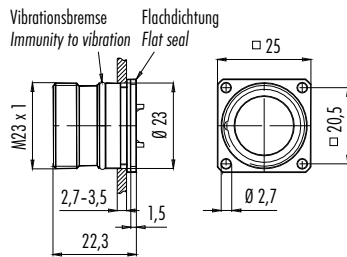

Bestell-Daten / Order Data

Polzahl Contacts	Bestell-Nr. (rechtsdrehend) Ordering-No. (clockwise)
6	99 4637 80 06
9	99 4603 80 09
12	99 4607 80 12
16	99 4611 80 16
19	99 4633 80 19

Technische Daten / Specifications

Polzahl	6	9	12	16	19	Number of contacts
Steckverbinder Verriegelung	schrauben/screw					Connector locking system
Anschlussart	löten/solder					Termination
Anschlussquerschnitt	2,5 mm <sup>2</sup> (AWG 14)	8x1,5 mm <sup>2</sup> (AWG 16)/1x2,5 mm <sup>2</sup> (AWG 14)	1,0 mm <sup>2</sup> (AWG 18)		16x1 mm <sup>2</sup> (AWG 18)/3x1,5 mm <sup>2</sup> (AWG 16)	Wire gauge
Kabeldurchlass	—					Cable outlet
Schutzart	IP67					Degree of protection
Mechanische Lebensdauer	> 50 Steckzyklen/> 50 mating cycles					Mechanical operation
Obere Grenztemperatur	+ 125 °C					Upper temperature
Untere Grenztemperatur	- 20 °C					Lower temperature
Bemessungsspannung	48 V					Rated voltage
Bemessungs-Stoßspannung	2500 V		1500 V			Rated impulse voltage
Verschmutzungsgrad	3					Pollution degree
Überspannungskategorie	II					Overvoltage categorie
Isolierstoffgruppe	III					Material group
Bemessungsstrom (40°C)	20 A	8 x 8 A/1 x 20 A		8 A	16 x 8 A/3 x 10 A	Rated current (40 °C)
Durchgangswiderstand	≤ 3 mΩ					Contact resistance
Material Kontakt	CuZn (Messing/brass)					Material of contact
Kontaktoberfläche	Au (Gold/gold)					Contact plating
Material Kontaktkörper	PBT/PA66					Material of contact body
Material Gehäuse	Zink Druckguss vernickelt/zinc diecasting nickel plated					Material of housing

**Flanschdose, Zentralbefestigung, PG 13,5**  
Female panel mount connector, center fastened, PG 13,5

Abbildung / Figure



Maßzeichnung / Drawing

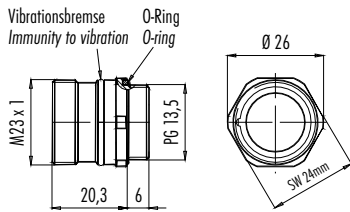

**Flanschdose, Frontmontage**  
Female panel mount connector, front fastened

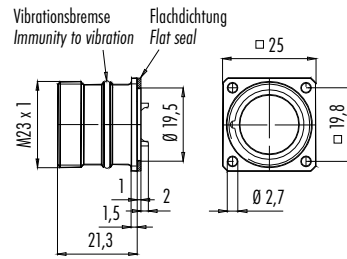

Bestell-Daten / Order Data

Polzahl Contacts	Bestell-Nr. (rechtsdrehend) Ordering-No. (clockwise)
6	99 4638 20 06
9	99 4604 20 09
12	99 4608 20 12
16	99 4612 20 16
19	99 4634 20 19

Polzahl Contacts	Bestell-Nr. (rechtsdrehend) Ordering-No. (clockwise)
6	99 4638 00 06
9	99 4604 00 09
12	99 4608 00 12
16	99 4612 00 16
19	99 4634 00 19

Technische Daten / Specifications

Polzahl	6	9	12	16	19	Number of contacts
Steckverbinder Verriegelung	schrauben/screw					Connector locking system
Anschlussart	löten/solder					Termination
Anschlussquerschnitt	2,5 mm <sup>2</sup> (AWG 14)	8x1,5 mm <sup>2</sup> (AWG 16)/1x2,5 mm <sup>2</sup> (AWG 14)	1,0 mm <sup>2</sup> (AWG 18)	16x1 mm <sup>2</sup> (AWG 18)/3x1,5 mm <sup>2</sup> (AWG 16)		Wire gauge
Kabeldurchlass	—					Cable outlet
Schutzart	IP67					Degree of protection
Mechanische Lebensdauer	> 50 Steckzyklen/> 50 mating cycles					Mechanical operation
Obere Grenztemperatur	+ 125 °C					Upper temperature
Untere Grenztemperatur	- 20 °C					Lower temperature
Bemessungsspannung	48 V					Rated voltage
Bemessungs-Stoßspannung	2500 V		1500 V			Rated impulse voltage
Verschmutzungsgrad	3					Pollution degree
Überspannungskategorie	II					Overvoltage categorie
Isolierstoffgruppe	III					Material group
Bemessungsstrom (40 °C)	20 A	8 x 8 A/1 x 20 A	8 A	16 x 8 A/3 x 10 A		Rated current (40 °C)
Durchgangswiderstand	≤ 3 mΩ					Contact resistance
Material Kontakt	CuSn (Bronze/bronze)					Material of contact
Kontaktoberfläche	Au (Gold/gold)					Contact plating
Material Kontaktkörper	PBT/PA66					Material of contact body
Material Gehäuse	Zink Druckguss vernickelt/zinc diecasting nickel plated					Material of housing

Flanschdose, Rückwandmontage

Female panel mount connector, fastened from back side

Abbildung / Figure



Maßzeichnung / Drawing

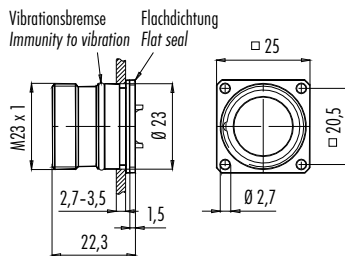

Bestell-Daten / Order Data

Polzahl Contacts	Bestell-Nr. (rechtsdrehend) Ordering-No. (clockwise)
6	99 4638 80 06
9	99 4604 80 09
12	99 4608 80 12
16	99 4612 80 16
19	99 4634 80 19

Technische Daten / Specifications

Polzahl	6	9	12	16	19	Number of contacts
Steckverbinder Verriegelung	schrauben/screw					Connector locking system
Anschlussart	löten/solder					Termination
Anschlussquerschnitt	2,5 mm <sup>2</sup> (AWG 14)	8x1,5 mm <sup>2</sup> (AWG 16)/1x2,5 mm <sup>2</sup> (AWG 14)	1,0 mm <sup>2</sup> (AWG 18)		16x1 mm <sup>2</sup> (AWG 18)/3x1,5 mm <sup>2</sup> (AWG 16)	Wire gauge
Kabeldurchlass	—					Cable outlet
Schutzart	IP67					Degree of protection
Mechanische Lebensdauer	> 50 Steckzyklen/> 50 mating cycles					Mechanical operation
Obere Grenztemperatur	+ 125 °C					Upper temperature
Untere Grenztemperatur	- 20 °C					Lower temperature
Bemessungsspannung	48 V					Rated voltage
Bemessungs-Stoßspannung	2500 V		1500 V			Rated impulse voltage
Verschmutzungsgrad	3					Pollution degree
Überspannungskategorie	II					Overvoltage categorie
Isolierstoffgruppe	III					Material group
Bemessungsstrom (40°C)	20 A	8 x 8 A/1 x 20 A		8 A	16 x 8 A/3 x 10 A	Rated current (40 °C)
Durchgangswiderstand	≤ 3 mΩ					Contact resistance
Material Kontakt	CuSn (Bronze/bronze)					Material of contact
Kontaktoberfläche	Au (Gold/gold)					Contact plating
Material Kontaktkörper	PBT/PA66					Material of contact body
Material Gehäuse	Zink Druckguss vernickelt/zinc diecasting nickel plated					Material of housing

**Polbilder**  
Contact arrangements

**Stifteinsatz (Steckseite), rechtsdrehend**  
Male insert (mating side), clockwise

**Buchseinsatz (Steckseite), rechtsdrehend**  
Female insert (mating side), clockwise

**6 pol**  
6 contacts

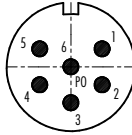

	X	Y
1	4,13	2,38
2	4,13	-2,38
3	0,00	-4,75
4	-4,13	-2,38
5	-4,13	2,38
6	0,00	0,00

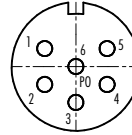

	X	Y
1	-4,13	2,38
2	-4,13	-2,38
3	0,00	-4,75
4	4,13	-2,38
5	4,13	2,38
6	0,00	0,00

**9 pol**  
9 contacts

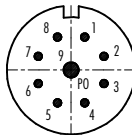

	X	Y
1	1,80	4,35
2	4,35	1,80
3	4,35	-1,80
4	1,80	-4,35
5	-1,80	-4,35
6	-4,35	-1,80
7	-4,35	1,80
8	-1,80	4,35
9	0,00	0,00

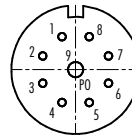

	X	Y
1	-1,80	4,35
2	-4,35	1,80
3	-4,35	-1,80
4	-1,80	-4,35
5	1,80	-4,35
6	4,35	-1,80
7	4,35	1,80
8	1,80	4,35
9	0,00	0,00

**12 pol**  
12 contacts

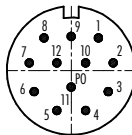

	X	Y
1	3,60	4,30
2	5,55	1,00
3	4,90	-2,80
4	1,90	-5,30
5	-1,90	-5,30
6	-4,90	-2,80
7	-5,55	1,00
8	-3,60	4,30
9	0,00	4,50
10	1,90	1,00
11	0,00	-2,20
12	-1,90	1,00

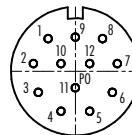

	X	Y
1	-3,60	4,30
2	-5,55	1,00
3	-4,90	-2,80
4	-1,90	-5,30
5	1,90	-5,30
6	4,90	-2,80
7	5,55	1,00
8	3,60	4,30
9	0,00	4,50
10	-1,90	1,00
11	0,00	-2,20
12	1,90	1,00

**16 pol**  
16 contacts

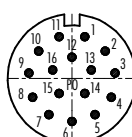

	X	Y
1	1,70	5,50
2	4,40	3,60
3	5,70	0,70
4	5,20	-2,50
5	3,05	-4,80
6	0,00	-5,70
7	-3,05	-4,80
8	-5,20	-2,50
9	-5,70	0,70
10	-4,40	3,60
11	-1,70	5,50
12	0,00	2,80
13	2,55	1,10
14	1,70	-2,00
15	-1,70	-2,00
16	-2,55	1,10

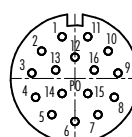

	X	Y
1	-1,70	5,50
2	-4,40	3,60
3	-5,70	0,70
4	-5,20	-2,50
5	-3,05	-4,80
6	0,00	-5,70
7	3,05	-4,80
8	5,20	-2,50
9	5,70	0,70
10	4,40	3,60
11	1,70	5,50
12	0,00	2,80
13	-2,55	1,10
14	-1,70	-2,00
15	1,70	-2,00
16	2,55	1,10

**19 pol**  
19 contacts

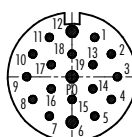

	X	Y
1	3,00	5,20
2	5,20	3,00
3	6,00	0,00
4	5,20	-3,00
5	3,00	-5,20
6	0,00	-6,00
7	-3,00	-5,20
8	-5,20	-3,00
9	-6,00	0,00
10	-5,20	3,00
11	-3,00	5,20
12	0,00	6,00
13	2,75	1,60
14	2,75	-1,60
15	0,00	-3,00
16	-2,75	-1,60
17	-2,75	1,60
18	0,00	3,00
19	0,00	0,00

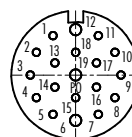

	X	Y
1	-3,00	5,20
2	-5,20	3,00
3	-6,00	0,00
4	-5,20	-3,00
5	-3,00	-5,20
6	0,00	-6,00
7	3,00	-5,20
8	5,20	-3,00
9	6,00	0,00
10	5,20	3,00
11	3,00	5,20
12	0,00	6,00
13	-2,75	1,60
14	-2,75	-1,60
15	0,00	-3,00
16	2,75	-1,60
17	2,75	1,60
18	0,00	3,00
19	0,00	0,00

**Schutzkappe für Kabelsteckverbinder, IP67**  
Protection cap for cable connectors, IP67

Abbildung / Figure



Maßzeichnung / Drawing

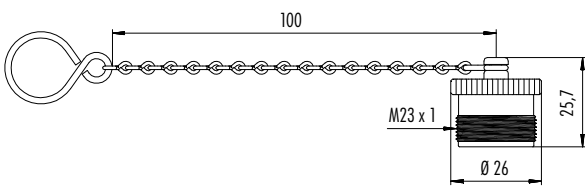

Bestell-Daten / Order Data

Bestell-Nr.  
Ordering-No.

08 1201 001 001

**Schutzkappe für Kupplungssteckverbinder, IP67**  
Protection cap for coupling connectors, IP67

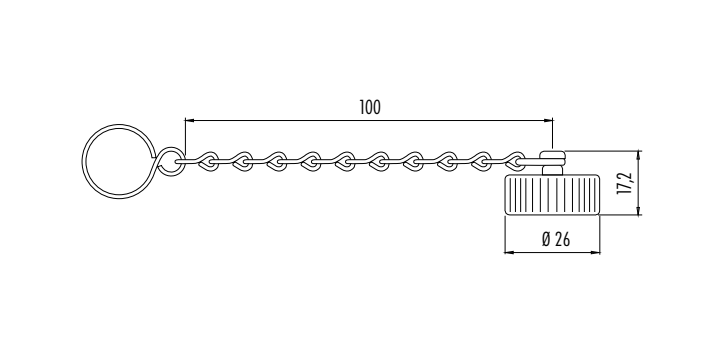

Bestell-Nr.  
Ordering-No.

08 1202 000 000

**Schutzkappe für Flanschsteckverbinder mit Innengewinde, IP67**  
Protection cap for panel mount connectors with inner thread, IP67

Abbildung / Figure



Maßzeichnung / Drawing

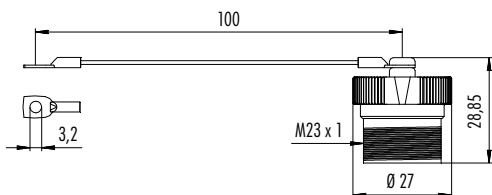

Bestell-Daten / Order Data

Bestell-Nr.  
Ordering-No.

08 1201 000 000

**Schutzkappe für Flanschsteckverbinder mit Aussengewinde, IP67**  
Protection cap for panel mount connectors with outer thread, IP67

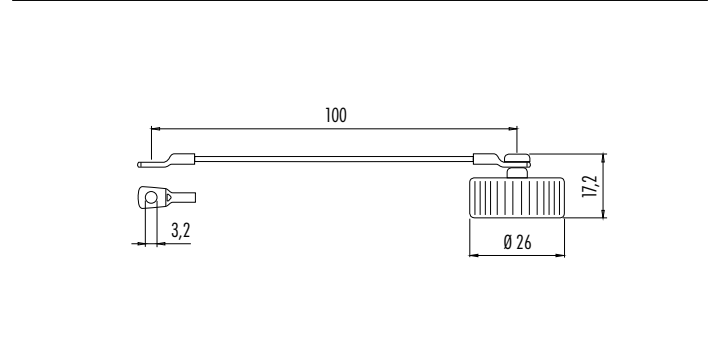

Bestell-Nr.  
Ordering-No.

08 1202 001 001



**Schutzkappe für Kabelsteckverbinder, IP40**  
Protection cap for cable connectors, IP40

Abbildung / Figure



Maßzeichnung / Drawing

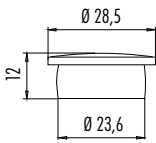

Bestell-Daten / Order Data

Bestell-Nr.  
Ordering-No.

08 1203 000 000

**Montageschlüssel**  
Mounting spanner

Abbildung / Figure



Maßzeichnung / Drawing

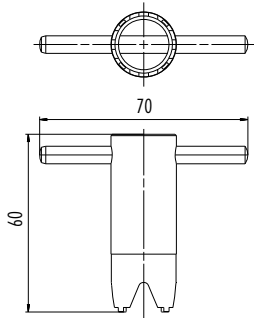

Bestell-Daten / Order Data

Bestell-Nr.  
Ordering-No.

08 1205 000 000

**Schutzkappe für Kupplungs- und Flanschsteckverbinder, IP40**  
Protection cap for coupling and panel mount connectors, IP40



Bestell-Nr.  
Ordering-No.

08 1204 000 000

Erdungshülse mit Dichtung  
Earth sleeve with seal

Abbildung / Figure



Maßzeichnung / Drawing

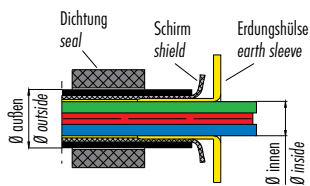

Bestell-Daten / Order Data

Kabeldurchmesser in mm/Cable diameter in mm innen/inside	ausßen/outside	Bestell-Nr. Ordering-No.
2,5	4,0	08 1200 040 025
2,5	5,0	08 1200 050 025
3,2	5,0	08 1200 050 032
3,2	6,0	08 1200 060 032
3,6	6,0	08 1200 060 036
3,6	7,5	08 1200 075 036
3,8	6,0	08 1200 060 038
3,8	7,5	08 1200 075 038
4,1	6,0	08 1200 060 041
4,6	7,5	08 1200 075 046
4,6	8,5	08 1200 085 046
5,2	7,5	08 1200 075 052
5,2	8,5	08 1200 085 052
5,2	10,0	08 1200 100 052
5,5	7,5	08 1200 075 055
5,5	8,5	08 1200 085 055
5,5	10,0	08 1200 100 055
6,2	10,0	08 1200 100 062
6,6	10,0	08 1200 100 066
7,0	10,0	08 1200 100 070
7,4	10,0	08 1200 100 074