



**FÜR MEDIZINISCHE
ANWENDUNGEN**
FOR MEDICAL APPLICATIONS

Bereich	Range	Serie Series	Seite Page	Schutzart Degree of protection	Spannung Voltage	Strom Current	Polzahl No. of contacts	Spannung Voltage	EMV EMC	Ø in mm Ø in mm	Anschlussart Termination						am Kabel angespritzt moulded connectors	Verriegelung Locking			
											löten solder	tauchlöten dip solder	SMT SMT	schrauben screw	crimpen crimp	Käfigzugfeder Wire clamp		Schneidklemm IDT	schrauben screw	Bajonett Bayonet	schnapp snap-in
Steckverbinder für medizinische Anwendungen Connectors for medical applications																					
Snap-in ELC	Snap-in ELC	570	4 – 9	IP54	150V	2 A	12		—	— (21)	•									•	
Snap-in IP67	Snap-in IP67	620	10 – 19	IP67	125V	1–3 A	3–8		—	11,5	•	•								•	
Snap-in IP67	Snap-in IP67	720	20 – 31	IP67	60/250V	2–7 A	3–12		—	16–19	•	•								•	
Bajonett NCC	Bayonet NCC	770	32 – 41	IP67	175V	2 A	8		—	16–19	•	•								•	

Übersicht

Summary

Snap-in ELC

Serie 570

- Snap-in Verriegelungssystem mit Rasthaken
- Schutzart Kabelteil im gesteckten und verriegelten Zustand IP54
- Schutzart Flanschteil ungesteckt IP54

- Kabelabgang 4–8 mm
- > 5000 Steckzyklen
- Ergonomisches Steckerdesign
- Farbe ähnlich RAL 9002

570 Series

- Snap-in locking system with snap hooks
- Degree of protection of cable part IP54 when mated and locked correctly
- Degree of protection of socket when not connected IP54
- Cable outlet 4–8 mm
- > 5000 mating cycles
- Ergonomic design of connector
- Colour similar to RAL 9002

Snap-in IP67

Serie 620

- Steckverbinder mit Schnappverriegelung
- Schutzart IP67
- Innenliegende Zugentlastung
- Einfache Montage
- Versionen mit Farbkodierung
- Farbe ähnlich RAL 9002
- Schutzkappen und Sicherungsclip in schwarz siehe Subminiatur Serie 620

620 Series

- Connectors with snap-in locking
- Degree of protection IP67
- Internal strain relief
- Easy assembly
- Versions with colour-coding
- Colour similar to RAL 9002
- Protection caps and safety clip in black see subminiature 620 series

Snap-in IP67

Serie 720

- Steckverbinder mit Schnappverriegelung
- Schutzart IP67
- Innenliegende Zugentlastung
- Einfache Montage
- Versionen mit Farbkodierung
- Farbe ähnlich RAL 9002
- Schutzkappen und Sicherungsclip in schwarz siehe Subminiatur Serie 720

720 Series

- Connectors with snap-in locking
- Degree of protection IP67
- Internal strain relief
- Easy assembly
- Versions with colour-coding
- Colour similar to RAL 9002
- Protection caps and safety clip in black see subminiature 720 series

Bajonett NCC

Serie 770

- Steckverbinder mit Bajonettverriegelung
- Schutzart Kabelteil im gesteckten und verriegelten Zustand IP67
- Schutzart Flanschteil ungesteckt IP67

- Kabelabgang 2,5–8 mm
- > 5000 Steckzyklen
- Einfache Montage
- Versionen mit Farbkodierung
- Farbe ähnlich RAL 9002

Bayonet NCC

770 Series

- Connectors with bayonet locking
- Degree of protection of cable part IP67 when mated and locked correctly
- Degree of protection of socket part when not connected IP67

- Cable outlet 2,5–8 mm
- > 5000 mating cycles
- Easy assembly
- Versions with colour-coding
- Colour similar to RAL 9002

Zusatzinformationen

- DEHP-frei ¹⁾
- Schock und Vibration gem. DIN EN 60601-1-11
- Fallprüfung gem. DIN EN 60601-1
- Biokompatibilität gem. DIN EN ISO 10993-5
- FDA-konform für wässrige Lebensmittel gem. Verordnung EG596/2009
- Desinfektionsmittelbeständigkeit auf Anfrage
- Luft- und Kriechstrecken auf Anfrage

Additional information

- DEHP-free ¹⁾
- Shock and vibration acc. to DIN EN 60601-1-11
- Drop test acc. to DIN EN 60601-1
- Biocompatibility acc. to DIN EN ISO 10993-5
- FDA compliant for aqueous foods acc. to regulation EG596/2009
- Disinfectant resistance on request
- Clearances and creepage distances on request

Steckverbinder für medizinische Anwendungen

Connectors for medical applications



Snap-in ELC für medizinische Anwendungen Snap-in ELC for medical applications

Kabelsteckverbinder

- Verriegelungssystem mit Rasthaken
- 12-polig
- Schutzart IP54 ¹⁾
- Lötanschluss
- Farbe in grauweiß ähnlich RAL 9002
- Ergonomisches Steckerdesign

Flanschsteckverbinder

- Verriegelungssystem mit Rasthaken
- 12-polig
- Schutzart IP54 ¹⁾
- Lötanschluss
- > 5000 Steckzyklen
- Farbe in grauweiß ähnlich RAL 9002
- Ergonomisches Steckerdesign



Cable Connectors

- Locking system with snap hooks
- 12 contacts
- Degree of protection IP54 ¹⁾
- Solder termination
- Colour in greywhite similar to RAL 9002
- Ergonomic design of connector

Panel Mount Connectors

- Locking system with snap hooks
- 12 contacts
- Degree of protection IP54 ¹⁾
- Solder termination
- > 5000 mating cycles
- Colour in greywhite similar to RAL 9002
- Ergonomic design of connector

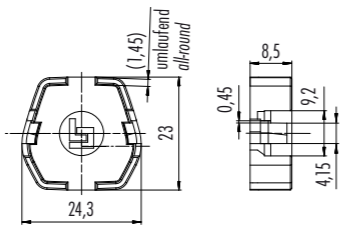
¹⁾Erläuterung der Schutzarten siehe technische Informationen./ ¹⁾Explanation of protection standards see technical information.

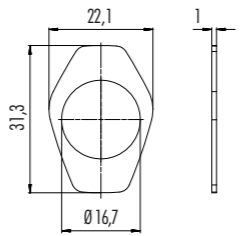
Bezeichnung / Description	Maßzeichnung / Drawing	Bestell-Nr. / Ordering-No.
<p>Lösewerkzeug für Kabelstecker Extraction tool for male cable connector</p> 		<p>07 0003 000</p>
<p>Flachdichtung Flat seal</p> 		<p>16 0334 000</p>



Steckverbinder für medizinische Anwendungen

Connectors for medical applications



Snap-in IP67 für medizinische Anwendungen Snap-in IP67 for medical applications

Kabelsteckverbinder

- Snap-in-Verriegelung
- 3 – 8-polig
- Schutzart IP67 ¹⁾
- Lötanschluss
- Durchmesser 11,5 mm
- Farbige Ausführungen
- Farbe in grauweiß ähnlich RAL 9002
- DEHP-frei ²⁾
- Ergonomisches Steckerdesign
- Geringes Gewicht
- Schutzkappen in schwarz siehe Subminiatur Serie 620

Flanschsteckverbinder

- Snap-in-Verriegelung
- 3 – 8-polig
- Schutzart IP67 ¹⁾
- Löt-/Tauchlötanschluss
- Durchmesser 11,5 mm
- Farbige Ausführungen
- Farbe in grauweiß ähnlich RAL 9002
- DEHP-frei ²⁾
- Schutzkappen in schwarz siehe Subminiatur Serie 620

Cable Connectors

- Snap-in locking system
- 3 – 8 contacts
- Degree of protection IP67 ¹⁾
- Solder termination
- Diameter 11.5 mm
- Coloured versions
- Colour in greywhite similar to RAL 9002
- DEHP-free ²⁾
- Ergonomic design of connector
- Low weight
- Protection caps in black see subminiature 620 series

Panel Mount Connectors

- Snap-in locking system
- 3 – 8 contacts
- Degree of protection IP67 ¹⁾
- Solder/dip solder termination
- Diameter 11.5 mm
- Coloured versions
- Colour in greywhite similar to RAL 9002
- DEHP-free ²⁾
- Protection caps in black see subminiature 620 series

¹⁾Erläuterung der Schutzarten siehe technische Informationen./ ¹⁾Explanation of protection standards see technical information.

²⁾Ausnahme Kontakte./ ²⁾Except contacts

Kabelstecker
Male cable connector

Kabelstecker, rot, blau, grün
Male cable connector, red, blue, green

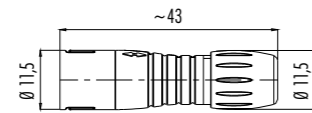

Polzahl Contacts	Kabeldurchlass max. Max. cable outlet	Bestell-Nr. Ordering-No.	Polzahl Contacts	Kabel-Ø max. Max. cable Ø	Rot Red	Blau Blue	Grün Green
3	3,5–5 mm	99 9205 400 03	3	3,5–5 mm	99 9205 450 03	99 9205 460 03	99 9205 470 03
4	3,5–5 mm	99 9209 400 04	4	3,5–5 mm	99 9209 450 04	99 9209 460 04	99 9209 470 04
5	3,5–5 mm	99 9213 400 05	5	3,5–5 mm	99 9213 450 05	99 9213 460 05	99 9213 470 05
8	3,5–5 mm	99 9225 400 08	8	3,5–5 mm	99 9225 450 08	99 9225 460 08	99 9225 470 08

Polzahl	3	4	5	8	Number of contacts
Steckverbinder Verriegelung	schnapp/snap-in				Connector locking system
Anschlussart	löten/solder				Termination
Anschlussquerschnitt	max. 0,25 mm ² (max. AWG 24)				Wire gauge
Kabeldurchlass	3,5–5 mm				Cable outlet
Schutzart	IP67				Degree of protection
Mechanische Lebensdauer	> 500 Steckzyklen/> 500 mating cycles				Mechanical operation
Obere Grenztemperatur	+ 85 °C				Upper temperature
Untere Grenztemperatur	– 25 °C				Lower temperature
Bemessungsspannung	125 V			63 V	Rated voltage
Bemessungs-Stoßspannung	1500 V			800 V	Rated impulse voltage
Verschmutzungsgrad	2				Pollution degree
Überspannungskategorie	II				Overvoltage categorie
Isolierstoffgruppe	II				Material group
Bemessungsstrom (40°C)	3 A	2,5 A	2 A	1 A	Rated current (40 °C)
Material Kontakt	CuZn (Messing/brass)				Material of contact
Kontaktoberfläche	Au (Gold/gold)				Contact plating
Material Kontaktkörper	PA				Material of contact body
Material Gehäuse	PA				Material of housing
Material Verriegelung	PA				Material of locking

Kabeldose
Female cable connector

Kabeldose, rot, blau, grün
Female cable connector, red, blue, green

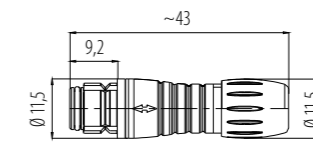

Polzahl Contacts	Kabeldurchlass max. Max. cable outlet	Bestell-Nr. Ordering-No.	Polzahl Contacts	Kabel-Ø max. Max. cable Ø	Rot Red	Blau Blue	Grün Green
3	3,5–5 mm	99 9206 400 03	3	3,5–5 mm	99 9206 450 03	99 9206 460 03	99 9206 470 03
4	3,5–5 mm	99 9210 400 04	4	3,5–5 mm	99 9210 450 04	99 9210 460 04	99 9210 470 04
5	3,5–5 mm	99 9214 400 05	5	3,5–5 mm	99 9214 450 05	99 9214 460 05	99 9214 470 05
8	3,5–5 mm	99 9226 400 08	8	3,5–5 mm	99 9226 450 08	99 9226 460 08	99 9226 470 08

Polzahl	3	4	5	8	Number of contacts
Steckverbinder Verriegelung	schnapp/snap-in				Connector locking system
Anschlussart	löten/solder				Termination
Anschlussquerschnitt	max. 0,25 mm ² (max. AWG 24)				Wire gauge
Kabeldurchlass	3,5–5 mm				Cable outlet
Schutzart	IP67				Degree of protection
Mechanische Lebensdauer	> 500 Steckzyklen/> 500 mating cycles				Mechanical operation
Obere Grenztemperatur	+ 85 °C				Upper temperature
Untere Grenztemperatur	– 25 °C				Lower temperature
Bemessungsspannung	125 V			63 V	Rated voltage
Bemessungs-Stoßspannung	1500 V			800 V	Rated impulse voltage
Verschmutzungsgrad	2				Pollution degree
Überspannungskategorie	II				Overvoltage categorie
Isolierstoffgruppe	II				Material group
Bemessungsstrom (40°C)	3 A	2,5 A	2 A	1 A	Rated current (40 °C)
Material Kontakt	CuSn (Bronze/bronze)				Material of contact
Kontaktoberfläche	Au (Gold/gold)				Contact plating
Material Kontaktkörper	PA				Material of contact body
Material Gehäuse	PA				Material of housing
Material Verriegelung	PA				Material of locking

Flanschstecker Male panel mount connector
 Flanschstecker, rot Male panel mount connector, red
 Flanschstecker, blau Male panel mount connector, blue
 Flanschstecker, grün Male panel mount connector, green
 Flanschstecker, tauchlöten Male panel mount connector, dip solder



Bohrbilder siehe Seite 17
Drilling schemes see page 17

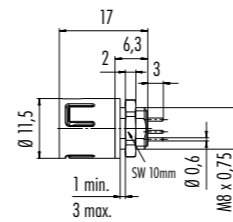
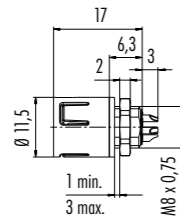

Polzahl Contacts	Bestell-Nr. Ordering-No.	Polzahl Contacts	Bestell-Nr. Ordering-No.	Polzahl Contacts	Bestell-Nr. Ordering-No.	Polzahl Contacts	Bestell-Nr. Ordering-No.	Polzahl Contacts	Bestell-Nr. Ordering-No.
3	99 9207 400 03	3	99 9207 050 03	3	99 9207 060 03	3	99 9207 070 03	3	99 9207 490 03
4	99 9211 400 04	4	99 9211 050 04	4	99 9211 060 04	4	99 9211 070 04	4	99 9211 490 04
5	99 9215 400 05	5	99 9215 050 05	5	99 9215 060 05	5	99 9215 070 05	5	99 9215 490 05
8	99 9227 400 08	8	99 9227 050 08	8	99 9227 060 08	8	99 9227 070 08	8	99 9227 490 08

Polzahl	3	4	5	8	Number of contacts
Steckverbinder Verriegelung	schnapp/snap-in				Connector locking system
Anschlussart	löten/tauchlöten/solder/dip solder				Termination
Anschlussquerschnitt	max. 0,25 mm ² (max. AWG 24)/ —				Wire gauge
Kabeldurchlass	—				Cable outlet
Schutzart	IP67				Degree of protection
Mechanische Lebensdauer	> 500 Steckzyklen/> 500 mating cycles				Mechanical operation
Obere Grenztemperatur	+ 85 °C				Upper temperature
Untere Grenztemperatur	- 25 °C				Lower temperature
Bemessungsspannung	125 V			63 V	Rated voltage
Bemessungs-Stoßspannung	1500 V			800 V	Rated impulse voltage
Verschmutzungsgrad	2				Pollution degree
Überspannungskategorie	II				Overvoltage categorie
Isolierstoffgruppe	II				Material group
Bemessungsstrom (40°C)	3 A	2,5 A	2 A	1 A	Rated current (40 °C)
Material Kontakt	CuZn (Messing/brass)				Material of contact
Kontaktoberfläche	Au (Gold/gold)				Contact plating
Material Kontaktkörper	PA				Material of contact body
Material Gehäuse	PA				Material of housing
Material Verriegelung	—				Material of locking

Flanschdose Female panel mount connector
 Flanschdose, rot Female panel mount connector, red
 Flanschdose, blau Female panel mount connector, blue
 Flanschdose, grün Female panel mount connector, green
 Flanschdose, tauchlöten Female panel mount connector, dip solder



Bohrbilder siehe Seite 17
Drilling schemes see page 17

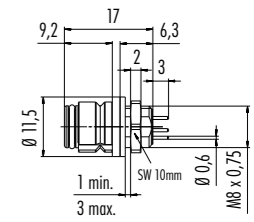
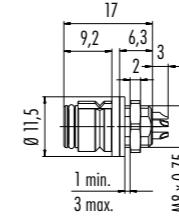

Polzahl Contacts	Bestell-Nr. Ordering-No.	Polzahl Contacts	Bestell-Nr. Ordering-No.	Polzahl Contacts	Bestell-Nr. Ordering-No.	Polzahl Contacts	Bestell-Nr. Ordering-No.	Polzahl Contacts	Bestell-Nr. Ordering-No.
3	99 9208 400 03	3	99 9208 050 03	3	99 9208 060 03	3	99 9208 070 03	3	99 9208 490 03
4	99 9212 400 04	4	99 9212 050 04	4	99 9212 060 04	4	99 9212 070 04	4	99 9212 490 04
5	99 9216 400 05	5	99 9216 050 05	5	99 9216 060 05	5	99 9216 070 05	5	99 9216 490 05
8	99 9228 400 08	8	99 9228 050 08	8	99 9228 060 08	8	99 9228 070 08	8	99 9228 490 08

Polzahl	3	4	5	8	Number of contacts
Steckverbinder Verriegelung	schnapp/snap-in				Connector locking system
Anschlussart	löten/tauchlöten/solder/dip solder				Termination
Anschlussquerschnitt	max. 0,25 mm ² (max. AWG 24)/ —				Wire gauge
Kabeldurchlass	—				Cable outlet
Schutzart	IP67				Degree of protection
Mechanische Lebensdauer	> 500 Steckzyklen/> 500 mating cycles				Mechanical operation
Obere Grenztemperatur	+ 85 °C				Upper temperature
Untere Grenztemperatur	- 25 °C				Lower temperature
Bemessungsspannung	125 V			63 V	Rated voltage
Bemessungs-Stoßspannung	1500 V			800 V	Rated impulse voltage
Verschmutzungsgrad	2				Pollution degree
Überspannungskategorie	II				Overvoltage categorie
Isolierstoffgruppe	II				Material group
Bemessungsstrom (40°C)	3 A	2,5 A	2 A	1 A	Rated current (40 °C)
Material Kontakt	CuSn (Bronze/bronze)				Material of contact
Kontaktoberfläche	Au (Gold/gold)				Contact plating
Material Kontaktkörper	PA				Material of contact body
Material Gehäuse	PA				Material of housing
Material Verriegelung	—				Material of locking

Montageanleitung
Assembly instruction

1. Abmanteln auf L = 12 mm.
2. Druckschraube, Klemmkorb, Dichtring und Kupplungshülse auf Kabel auffädeln.
3. O-Ring auf Kontakteinsatz aufziehen.
4. Litzen abisolieren und anlöten.
5. Kupplungshülse aufschrauben.
6. Druckschraube festdrehen.

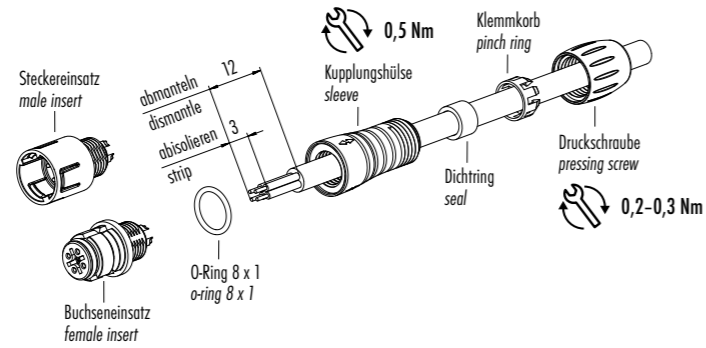

1. Dismantle cable to 12 mm length.
2. Bead pressing screw, pinch ring, seal and sleeve to cable.
3. Fit O-ring on the contact insert.
4. Strip and solder single wires.
5. Screw on sleeve.
6. Tighten pressing screw.

Einzelteildarstellung
Component part drawing

Flanschsteckverbinder, löten
Panel mount connectors, solder

Flanschsteckverbinder, tauchlöten
Panel mount connectors, dip solder

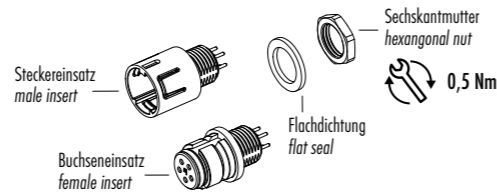
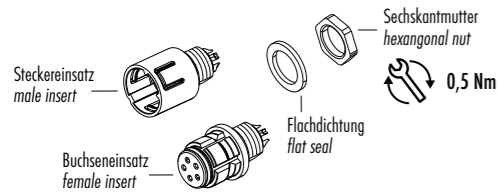

Montage Adapter
Assembly of adapter

Montage Adapter, von vorn verschraubbar
Assembly of adapter, front fastened

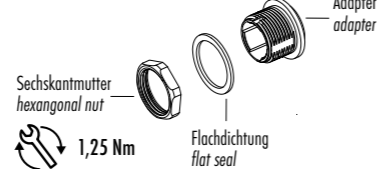
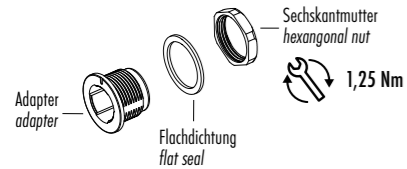

Adapter
Adapter

Adapter, von vorn verschraubbar
Adapter, front fastened

Die Markierung des Adapters muss mit der Kodiernase des Einsatzes übereinstimmen
The marking of the adapter must be conform with the coding nut of the insert

Die Markierung des Adapters muss mit der Kodiernase des Einsatzes übereinstimmen
The marking of the adapter must be conform with the coding nut of the insert

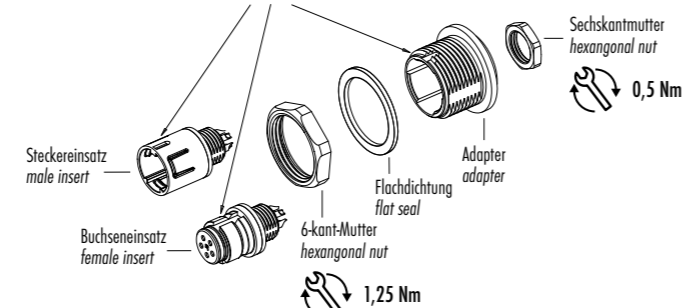
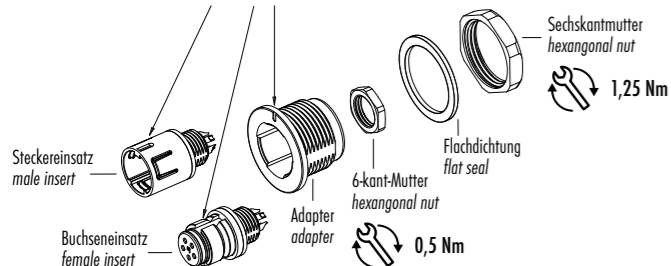

Einsätze müssen separat bestellt werden
Inserts have to be ordered separately

Einsätze müssen separat bestellt werden
Inserts have to be ordered separately

Polbilder
Contact arrangements

Stifteinsatz (Steckseite)
Male insert (mating side)

Buchseinsatz (Steckseite)
Female insert (mating side)

3 pol
3 contacts

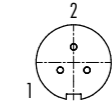
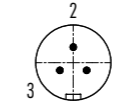

4 pol
4 contacts

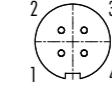
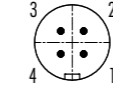

5 pol
5 contacts

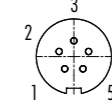
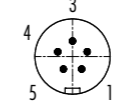

8 pol
8 contacts

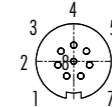
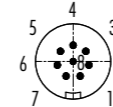

Bohrbilder Stifteinsatz (Leiterplatte)
Drilling schemes male insert (PCB)

Bohrbilder Buchseinsatz (Leiterplatte)
Drilling schemes female insert (PCB)

3 pol
3 contacts

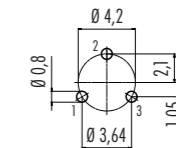
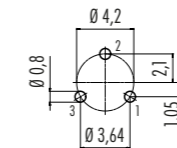

4 pol
4 contacts

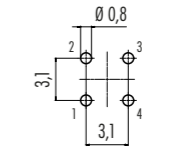
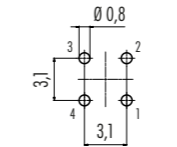

5 pol
5 contacts

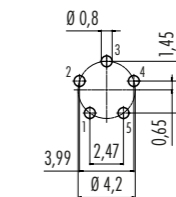
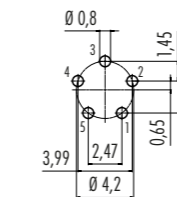

8 pol
8 contacts

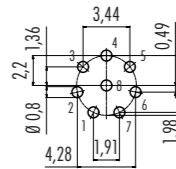
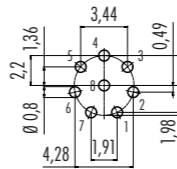



Montageausschnitt
Panel cut out

Flanschsteckverbinder
Panel mount connectors

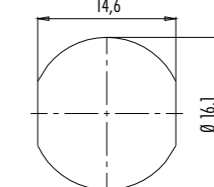
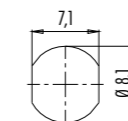
Adapter
Adapter

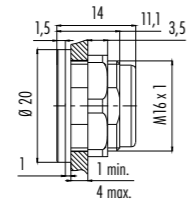

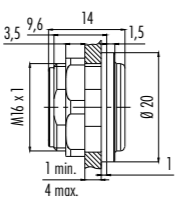
Bezeichnung / Description	Maßzeichnung / Drawing	Bestell-Nr. / Ordering-No.
<p>Adapter für Flanschsteckverbinder Adapter for panel mount connectors</p> 		<p>08 2636 400 001</p>
<p>Adapter für Flanschsteckverbinder, von vorn verschraubt Adapter for panel mount connectors, front fastened</p> 		<p>08 2629 400 001</p>

Anwendungsbeispiel für Adapter
 Example for use for adapter

Flanschstecker
 Male panel mount connector



Flanschstecker mit Adapter
 Male panel mount connector
 with adapter



Flanschdose
 Female panel mount connector



Flanschdose mit Adapter, von
 vorn verschraubbar
 Female panel mount connector
 with adapter, front fastened



Steckverbinder für medizinische Anwendungen

Connectors for medical applications



Snap-in IP67 für medizinische Anwendungen Snap-in IP67 for medical applications

Kabelsteckverbinder

- Snap-in-Verriegelung
- 3 – 12-polig
- Schutzart IP67 ¹⁾
- Lötanschluss
- Durchmesser 16 mm
- Farbige Ausführungen
- Farbe in grauweiß ähnlich RAL 9002
- DEHP-frei ²⁾
- Ergonomisches Steckerdesign
- Geringes Gewicht
- Schutzkappen in schwarz siehe Miniatur Serie 720

Flanschsteckverbinder

- Snap-in-Verriegelung
- 3 – 12-polig
- Schutzart IP67 ¹⁾
- Löt-/Tauchlötanschluss
- Durchmesser 16 mm
- Farbige Ausführungen
- Farbe in grauweiß ähnlich RAL 9002
- DEHP-frei ²⁾
- Schutzkappen in schwarz siehe Miniatur Serie 720

Cable Connectors

- Snap-in locking system
- 3 – 12 contacts
- Degree of protection IP67 ¹⁾
- Solder termination
- Diameter 16 mm
- Coloured versions
- Colour in greywhite similar to RAL 9002
- DEHP-free ²⁾
- Ergonomic design of connector
- Low weight
- Protection caps in black see miniature 720 series

Panel Mount Connectors

- Snap-in locking system
- 3 – 12 contacts
- Degree of protection IP67 ¹⁾
- Solder/dip solder termination
- Diameter 16 mm
- Coloured versions
- Colour in greywhite similar to RAL 9002
- DEHP-free ²⁾
- Protection caps in black see miniature 720 series

¹⁾Erläuterung der Schutzarten siehe technische Informationen./ ¹⁾Explanation of protection standards see technical information.

²⁾Ausnahme Kontakte./ ²⁾Except contacts

Kabelstecker
Male cable connector

Kabelstecker
Male cable connector

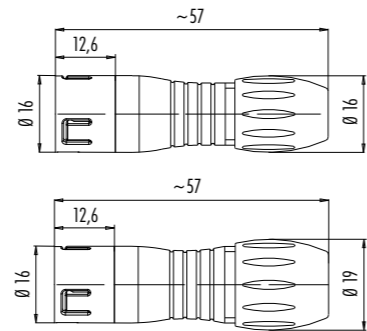
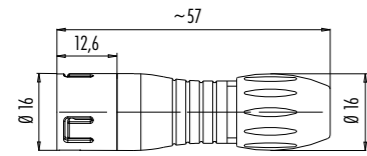

Polzahl Contacts	Kabeldurchlass Cable outlet	Bestell-Nr. Ordering-No.	Polzahl Contacts	Kabeldurchlass Cable outlet	Bestell-Nr. Ordering-No.
3	2,5–4 mm	99 9105 403 03	3	4–6 mm	99 9105 400 03
5	2,5–4 mm	99 9113 403 05	5	4–6 mm	99 9113 400 05
8	2,5–4 mm	99 9125 403 08	8	4–6 mm	99 9125 400 08
12	2,5–4 mm	—	12	6–8 mm	99 9133 402 12

Polzahl	3	5	8	12	Number of contacts
Steckverbinder Verriegelung	schnapp/snap-in				Connector locking system
Anschlussart	löten/solder				Termination
Anschlussquerschnitt	max. 0,75 mm ² (max. AWG 18)		max. 0,25 mm ² (max. AWG 24)		Wire gauge
Kabeldurchlass	2,5–4 mm, 4–6 mm			6–8 mm	Cable outlet
Schutzart	IP67				Degree of protection
Mechanische Lebensdauer	> 500 Steckzyklen/> 500 mating cycles				Mechanical operation
Obere Grenztemperatur	+ 85 °C				Upper temperature
Untere Grenztemperatur	– 25 °C				Lower temperature
Bemessungsspannung	250 V	125 V	125 V	60 V	Rated voltage
Bemessungs-Stoßspannung	2500 V	1500 V	1500 V	800 V	Rated impulse voltage
Verschmutzungsgrad	2				Pollution degree
Überspannungskategorie	II				Overvoltage categorie
Isolierstoffgruppe	II				Material group
Bemessungsstrom (40°C)	7 A	5 A	2 A		Rated current (40 °C)
Material Kontakt	CuZn (Messing/brass)				Material of contact
Kontaktoberfläche	Au (Gold/gold)				Contact plating
Material Kontaktkörper	PA				Material of contact body
Material Gehäuse	PA				Material of housing
Material Verriegelung	PA				Material of locking

Kabelstecker, rot, blau, grün
Male cable connector, red, blue, green

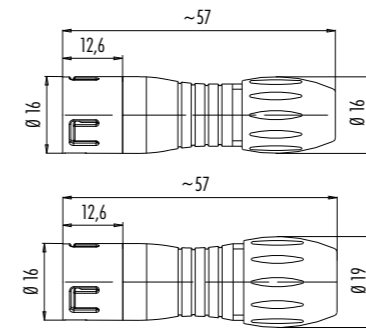

Polzahl Contacts	Kabeldurchlass Cable outlet	Rot Red	Blau Blue	Grün Green
3	4–6 mm	99 9105 450 03	99 9105 460 03	99 9105 470 03
5	4–6 mm	99 9113 450 05	99 9113 460 05	99 9113 470 05
8	4–6 mm	99 9125 450 08	99 9125 460 08	99 9125 470 08
12	6–8 mm	99 9133 452 12	99 9133 462 12	99 9133 472 12

Polzahl	3	5	8	12	Number of contacts
Steckverbinder Verriegelung	schnapp/snap-in				Connector locking system
Anschlussart	löten/solder				Termination
Anschlussquerschnitt	max. 0,75 mm ² (max. AWG 18)		max. 0,25 mm ² (max. AWG 24)		Wire gauge
Kabeldurchlass	4–6 mm			6–8 mm	Cable outlet
Schutzart	IP67				Degree of protection
Mechanische Lebensdauer	> 500 Steckzyklen/> 500 mating cycles				Mechanical operation
Obere Grenztemperatur	+ 85 °C				Upper temperature
Untere Grenztemperatur	– 25 °C				Lower temperature
Bemessungsspannung	250 V	125 V	125 V	60 V	Rated voltage
Bemessungs-Stoßspannung	2500 V	1500 V	1500 V	800 V	Rated impulse voltage
Verschmutzungsgrad	2				Pollution degree
Überspannungskategorie	II				Overvoltage categorie
Isolierstoffgruppe	II				Material group
Bemessungsstrom (40°C)	7 A	5 A	2 A		Rated current (40 °C)
Material Kontakt	CuZn (Messing/brass)				Material of contact
Kontaktoberfläche	Au (Gold/gold)				Contact plating
Material Kontaktkörper	PA				Material of contact body
Material Gehäuse	PA				Material of housing
Material Verriegelung	PA				Material of locking

Kabeldose
Female cable connector

Kabeldose
Female cable connector

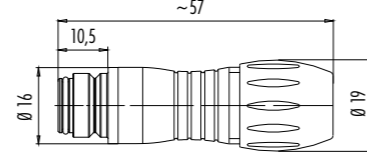
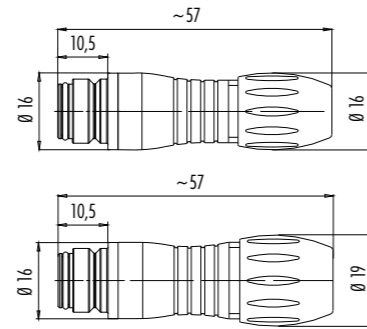
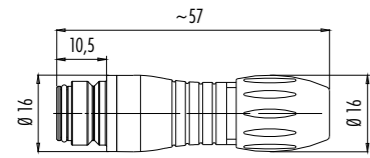

Polzahl Contacts	Kabeldurchlass Cable outlet	Bestell-Nr. Ordering-No.	Polzahl Contacts	Kabeldurchlass Cable outlet	Bestell-Nr. Ordering-No.
3	2,5–4 mm	99 9106 403 03	3	4–6 mm	99 9106 400 03
5	2,5–4 mm	99 9114 403 05	5	4–6 mm	99 9114 400 05
8	2,5–4 mm	99 9126 403 08	8	4–6 mm	99 9126 400 08
12	2,5–4 mm	—	12	6–8 mm	99 9134 402 12

Polzahl	3	5	8	12	Number of contacts
Steckverbinder Verriegelung	schnapp/snap-in				Connector locking system
Anschlussart	löten/solder				Termination
Anschlussquerschnitt	max. 0,75 mm ² (max. AWG 18)		max. 0,25 mm ² (max. AWG 24)		Wire gauge
Kabeldurchlass	2,5–4 mm, 4–6 mm			6–8 mm	Cable outlet
Schutzart	IP67				Degree of protection
Mechanische Lebensdauer	> 500 Steckzyklen/> 500 mating cycles				Mechanical operation
Obere Grenztemperatur	+ 85 °C				Upper temperature
Untere Grenztemperatur	– 25 °C				Lower temperature
Bemessungsspannung	250 V	125 V	125 V	60 V	Rated voltage
Bemessungs-Stoßspannung	2500 V	1500 V	1500 V	800 V	Rated impulse voltage
Verschmutzungsgrad	2				Pollution degree
Überspannungskategorie	II				Overvoltage categorie
Isolierstoffgruppe	II				Material group
Bemessungsstrom (40°C)	7 A	5 A	2 A		Rated current (40 °C)
Material Kontakt	CuSn (Bronze/bronze)				Material of contact
Kontaktoberfläche	Au (Gold/gold)				Contact plating
Material Kontaktkörper	PA				Material of contact body
Material Gehäuse	PA				Material of housing
Material Verriegelung	PA				Material of locking

Kabeldose, rot, blau, grün
Female cable connector, red, blue, green

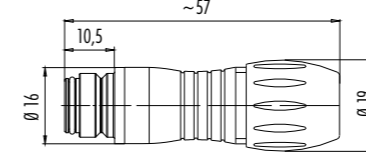
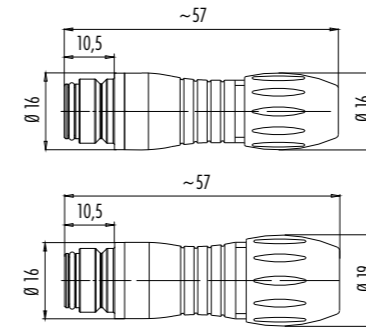

Polzahl Contacts	Kabeldurchlass Cable outlet	Rot Red	Blau Blue	Grün Green
3	4–6 mm	99 9106 450 03	99 9106 460 03	99 9106 470 03
5	4–6 mm	99 9114 450 05	99 9114 460 05	99 9114 470 05
8	4–6 mm	99 9126 450 08	99 9126 460 08	99 9126 470 08
12	6–8 mm	99 9134 452 12	99 9134 462 12	99 9134 472 12

Polzahl	3	5	8	12	Number of contacts
Steckverbinder Verriegelung	schnapp/snap-in				Connector locking system
Anschlussart	löten/solder				Termination
Anschlussquerschnitt	max. 0,75 mm ² (max. AWG 18)		max. 0,25 mm ² (max. AWG 24)		Wire gauge
Kabeldurchlass	4–6 mm			6–8 mm	Cable outlet
Schutzart	IP67				Degree of protection
Mechanische Lebensdauer	> 500 Steckzyklen/> 500 mating cycles				Mechanical operation
Obere Grenztemperatur	+ 85 °C				Upper temperature
Untere Grenztemperatur	– 25 °C				Lower temperature
Bemessungsspannung	250 V	125 V	125 V	60 V	Rated voltage
Bemessungs-Stoßspannung	2500 V	1500 V	1500 V	800 V	Rated impulse voltage
Verschmutzungsgrad	2				Pollution degree
Überspannungskategorie	II				Overvoltage categorie
Isolierstoffgruppe	II				Material group
Bemessungsstrom (40°C)	7 A	5 A	2 A		Rated current (40 °C)
Material Kontakt	CuSn (Bronze/bronze)				Material of contact
Kontaktoberfläche	Au (Gold/gold)				Contact plating
Material Kontaktkörper	PA				Material of contact body
Material Gehäuse	PA				Material of housing
Material Verriegelung	PA				Material of locking

- Flanschstecker Male panel mount connector
- Flanschstecker, rot Male panel mount connector, red
- Flanschstecker, blau Male panel mount connector, blue
- Flanschstecker, grün Male panel mount connector, green
- Flanschstecker, tauchlöten Male panel mount connector, dip solder



Bohrbilder siehe Seite 29
Drilling schemes see page 29

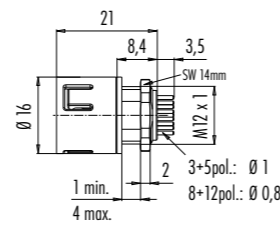
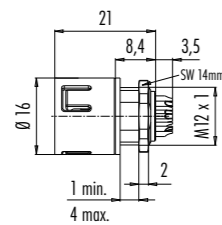

Polzahl Contacts	Bestell-Nr. Ordering-No.	Polzahl Contacts	Bestell-Nr. Ordering-No.	Polzahl Contacts	Bestell-Nr. Ordering-No.	Polzahl Contacts	Bestell-Nr. Ordering-No.	Polzahl Contacts	Bestell-Nr. Ordering-No.
3	99 9107 400 03	3	99 9107 50 03	3	99 9107 60 03	3	99 9107 70 03	3	99 9107 490 03
5	99 9115 400 05	5	99 9115 50 05	5	99 9115 60 05	5	99 9115 70 05	5	99 9115 490 05
8	99 9127 400 08	8	99 9127 50 08	8	99 9127 60 08	8	99 9127 70 08	8	99 9127 490 08
12	99 9135 400 12	12	99 9135 50 12	12	99 9135 60 12	12	99 9135 70 12	12	99 9135 490 12

Polzahl	3	5	8	12	Number of contacts
Steckverbinder Verriegelung	schnapp/snap-in				Connector locking system
Anschlussart	löten/tauchlöten/solder/dip solder				Termination
Anschlussquerschnitt	max. 0,75 mm ² (max. AWG 18)		max. 0,25 mm ² (max. AWG 24)		Wire gauge
Kabeldurchlass	—				Cable outlet
Schutzart	IP67				Degree of protection
Mechanische Lebensdauer	> 500 Steckzyklen/> 500 mating cycles				Mechanical operation
Obere Grenztemperatur	+ 85 °C				Upper temperature
Untere Grenztemperatur	- 25 °C				Lower temperature
Bemessungsspannung	250 V	125 V	125 V	60 V	Rated voltage
Bemessungs-Stoßspannung	2500 V	1500 V	1500 V	800 V	Rated impulse voltage
Verschmutzungsgrad	2				Pollution degree
Überspannungskategorie	II				Overvoltage categorie
Isolierstoffgruppe	II				Material group
Bemessungsstrom (40°C)	7 A	5 A	2 A		Rated current (40 °C)
Material Kontakt	CuZn (Messing/brass)				Material of contact
Kontaktoberfläche	Au (Gold/gold)				Contact plating
Material Kontaktkörper	PA				Material of contact body
Material Gehäuse	PA				Material of housing
Material Verriegelung	—				Material of locking

- Flanschdose Female panel mount connector
- Flanschdose, rot Female panel mount connector, red
- Flanschdose, blau Female panel mount connector, blue
- Flanschdose, grün Female panel mount connector, green
- Flanschdose, tauchlöten Female panel mount connector, dip solder



Bohrbilder siehe Seite 29
Drilling schemes see page 29

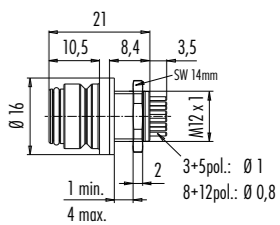
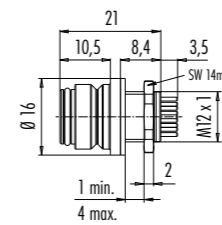

Polzahl Contacts	Bestell-Nr. Ordering-No.	Polzahl Contacts	Bestell-Nr. Ordering-No.	Polzahl Contacts	Bestell-Nr. Ordering-No.	Polzahl Contacts	Bestell-Nr. Ordering-No.	Polzahl Contacts	Bestell-Nr. Ordering-No.
3	99 9108 400 03	3	99 9108 50 03	3	99 9108 60 03	3	99 9108 70 03	3	99 9108 490 03
5	99 9116 400 05	5	99 9116 50 05	5	99 9116 60 05	5	99 9116 70 05	5	99 9116 490 05
8	99 9128 400 08	8	99 9128 50 08	8	99 9128 60 08	8	99 9128 70 08	8	99 9128 490 08
12	99 9136 400 12	12	99 9136 50 12	12	99 9136 60 12	12	99 9136 70 12	12	99 9136 490 12

Polzahl	3	5	8	12	Number of contacts
Steckverbinder Verriegelung	schnapp/snap-in				Connector locking system
Anschlussart	löten/tauchlöten/solder/dip solder				Termination
Anschlussquerschnitt	max. 0,75 mm ² (max. AWG 18)		max. 0,25 mm ² (max. AWG 24)		Wire gauge
Kabeldurchlass	—				Cable outlet
Schutzart	IP67				Degree of protection
Mechanische Lebensdauer	> 500 Steckzyklen/> 500 mating cycles				Mechanical operation
Obere Grenztemperatur	+ 85 °C				Upper temperature
Untere Grenztemperatur	- 25 °C				Lower temperature
Bemessungsspannung	250 V	125 V	125 V	60 V	Rated voltage
Bemessungs-Stoßspannung	2500 V	1500 V	1500 V	800 V	Rated impulse voltage
Verschmutzungsgrad	2				Pollution degree
Überspannungskategorie	II				Overvoltage categorie
Isolierstoffgruppe	II				Material group
Bemessungsstrom (40°C)	7 A	5 A	2 A		Rated current (40 °C)
Material Kontakt	CuSn (Bronze/bronze)				Material of contact
Kontaktoberfläche	Au (Gold/gold)				Contact plating
Material Kontaktkörper	PA				Material of contact body
Material Gehäuse	PA				Material of housing
Material Verriegelung	—				Material of locking

Montageanleitung
Assembly instruction

1. Kupplungshülse, Dichtring, Klemmkorb und Druckschraube auf Kabel auffädeln.
2. Kabel abmanteln auf L = 15 mm.
3. Litzen abisolieren und anschließen.
4. Kupplungshülse auf montierten Kontakteinsatz schrauben.
5. Dichtring und Klemmkorb in Kupplungshülse schieben und mit Druckschraube festdrehen.

1. Bead sleeve, seal, pinch ring and pressing screw to cable.
2. Dismantle cable to 15 mm length.
3. Strip and connect single wires.
4. Screw the sleeve onto the assembled contact insert.
5. Push seal and pinch ring into the sleeve and tighten it with the pressing screw.

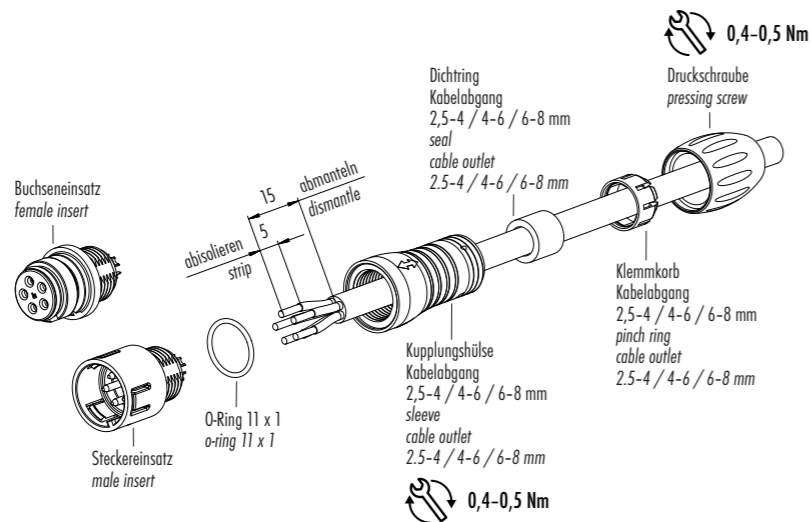

Einzelteildarstellung
Component part drawing

Flanschsteckverbinder, löten
Panel mount connectors, solder

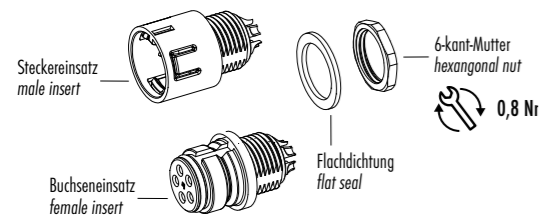

Flanschsteckverbinder, tauchlöten
Panel mount connectors, dip solder

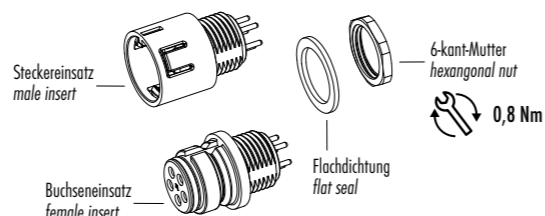

Montage Adapter
Assembly of adapter

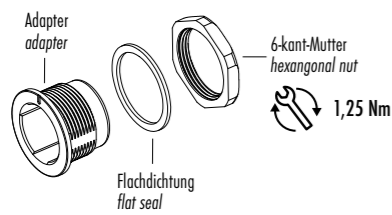

Montage Adapter, von vorn verschraubbar
Assembly of adapter, front fastened

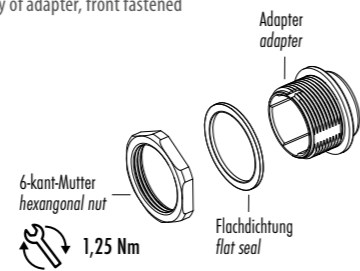

Adapter
Adapter

Die Markierung des Adapters muss mit der Koderhase des Einsatzes übereinstimmen
The marking of the adapter must conform with the coding nut of the insert

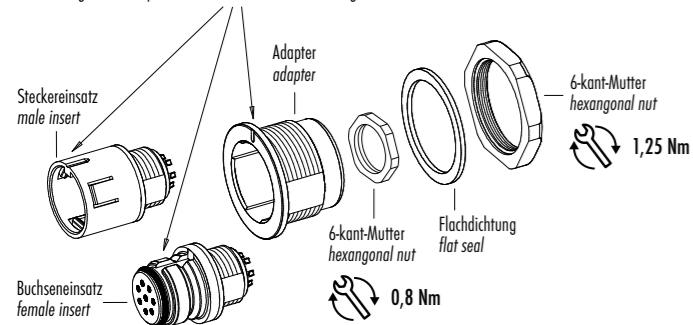

Einsätze müssen separat bestellt werden
Inserts have to be ordered separately

Adapter, von vorn verschraubbar
Adapter, front fastened

Die Markierung des Adapters muss mit der Koderhase des Einsatzes übereinstimmen
The marking of the adapter must conform with the coding nut of the insert

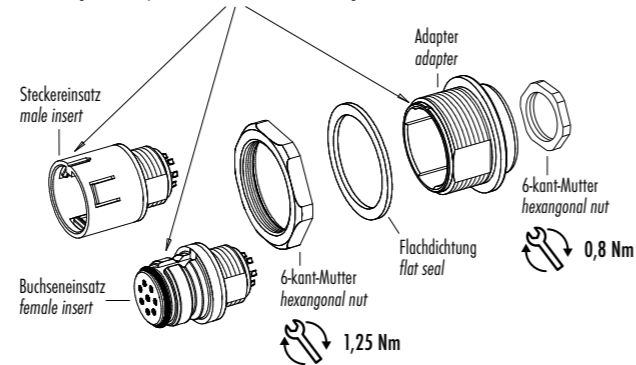

Einsätze müssen separat bestellt werden
Inserts have to be ordered separately

Polbilder
Contact arrangements

Stifteinsatz (Steckseite)
Male insert (mating side)

Buchseinsatz (Steckseite)
Female insert (mating side)

3 pol
3 contacts

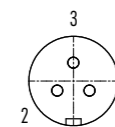
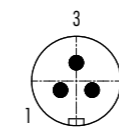

5 pol
5 contacts

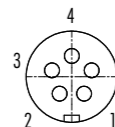
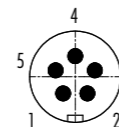

8 pol
8 contacts

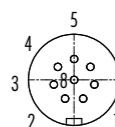
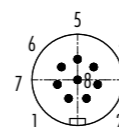

12 pol
12 contacts

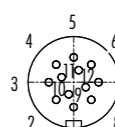
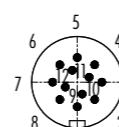

Bohrbilder Stifteinsatz (Leiterplatte), ungeschirmt
Drilling schemes male insert (PCB), unshielded

Bohrbilder Buchseinsatz (Leiterplatte), ungeschirmt
Drilling schemes female insert (PCB), unshielded

3 pol
3 contacts

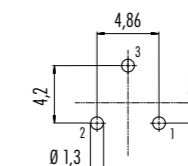
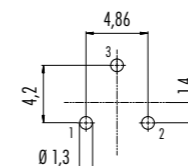

5 pol
5 contacts

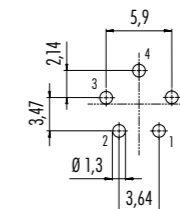
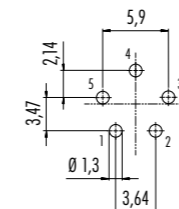

8 pol
8 contacts

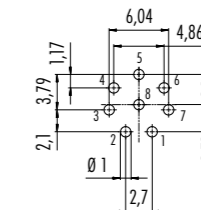
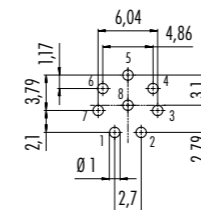

12 pol
12 contacts

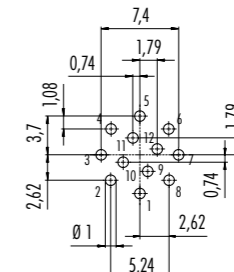
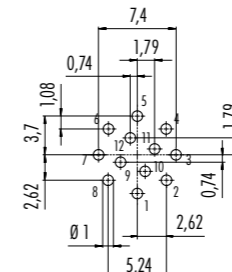

Montageausschnitt
Panel cut out

Flanschsteckverbinder
Socket connectors

Adapter
Adapter

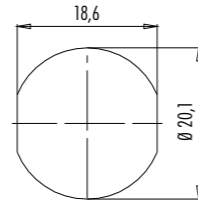
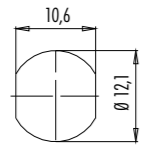

Bezeichnung / Description	Maßzeichnung / Drawing	Bestell-Nr. / Ordering-No.
---------------------------	------------------------	----------------------------

Adapter für Flanschsteckverbinder
Adapter for panel mount connectors

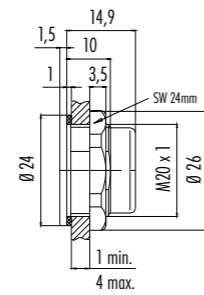

08 2433 400 001

Adapter für Flanschsteckverbinder, von vorn verschraubt
Adapter for panel mount connectors, front fastened

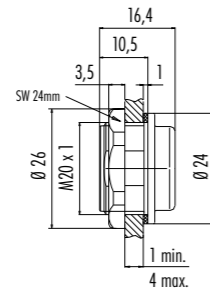

08 2434 400 001

Anwendungsbeispiel für Adapter
Example for use for adapter

Flanschstecker
Male panel mount connector



Flanschstecker mit Adapter
Male panel mount connector with adapter



Flanschdose
Female panel mount connector



Flanschdose mit Adapter, von vorn verschraubbar
Female panel mount connector with adapter, front fastened



Steckverbinder für medizinische Anwendungen

Connectors for medical applications



Bajonett NCC für medizinische Anwendungen Bayonet NCC for Medical Applications

Kabelsteckverbinder

- Bajonett-Verriegelung
- 8-polig
- Schutzart IP67 ¹⁾
- Lötanschluss
- Durchmesser 19,9 mm
- Farbe in grauweiß ähnlich RAL 9002
- Farbige Ausführungen auf Anfrage
- DEHP-frei ²⁾
- Ergonomisches Steckerdesign
- Geringes Gewicht

Cable Connectors

- Bayonet locking system
- 8 contacts
- Degree of protection IP67 ¹⁾
- Solder termination
- Diameter 19.9 mm
- Colour in greywhite similar to RAL 9002
- Coloured versions upon request
- DEHP-free ²⁾
- Ergonomic design of connector
- Low weight

Flanschsteckverbinder

- Bajonett-Verriegelung
- 8-polig
- Schutzart IP67 ¹⁾ auch in ungestecktem Zustand
- Löt-/Tauchlötanschluss
- Durchmesser 17,6 mm
- > 5000 Steckzyklen
- Farbe in grauweiß ähnlich RAL 9002
- Farbige Ausführungen auf Anfrage
- DEHP-frei ²⁾

Panel Mount Connectors

- Bayonet locking system
- 8 contacts
- Degree of protection IP67 ¹⁾ even when not connected
- Solder/dip solder termination
- Diameter 17.6 mm
- > 5000 mating cycles
- Colour in greywhite similar to RAL 9002
- Coloured versions upon request
- DEHP-free ²⁾

¹⁾Erläuterung der Schutzarten siehe technische Informationen./ ¹⁾Explanation of protection standards see technical information.

²⁾Ausnahme Kontakte./ ²⁾Except contacts

Kabelstecker, weiß
Male cable connector, white

Kabelstecker, rot, blau, grün
Male cable connector, red, blue, green

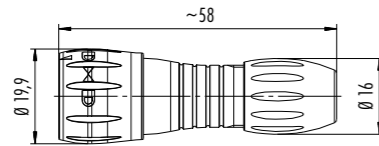

Polzahl Contacts	Kabeldurchlass Cable outlet	Bestell-Nr. Ordering-No.	Polzahl Contacts	Kabeldurchlass Cable outlet	Rot Red	Blau Blue	Grün Green
8	2,5–4 mm	99 0771 400 08	8	2,5–4 mm	99 0771 450 08	99 0771 460 08	99 0771 470 08

Polzahl	8	Number of contacts
Steckverbinder Verriegelung	Bajonett/bayonet	Connector locking system
Anschlussart	löten/solder	Termination
Anschlussquerschnitt	0,25 mm ² (AWG 24)	Wire gauge
Kabeldurchlass	2,5–4 mm, 4–6 mm, 6–8 mm	Cable outlet
Schutzart	IP67	Degree of protection
Mechanische Lebensdauer	> 5000 Steckzyklen/> 5000 mating cycles	Mechanical operation
Obere Grenztemperatur	+ 85 °C	Upper temperature
Untere Grenztemperatur	– 25 °C	Lower temperature
Bemessungsspannung	175 V	Rated voltage
Bemessungs-Stoßspannung	1750 V	Rated impulse voltage
Verschmutzungsgrad	2	Pollution degree
Überspannungskategorie	II	Overvoltage categorie
Isolierstoffgruppe	II	Material group
Bemessungsstrom (40°C)	2 A	Rated current (40 °C)
Material Kontakt	CuZn (Messing/brass)	Material of contact
Kontaktoberfläche	Au (Gold/gold)	Contact plating
Material Kontaktkörper	PA	Material of contact body
Material Gehäuse	PA	Material of housing
Material Verriegelung	PA	Material of locking

Kabelstecker, weiß
Male cable connector, white

Kabelstecker, rot, blau, grün
Male cable connector, red, blue, green

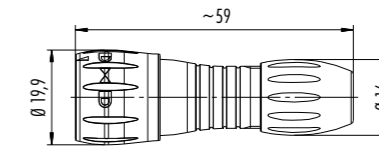

Polzahl Contacts	Kabeldurchlass Cable outlet	Bestell-Nr. Ordering-No.	Polzahl Contacts	Kabeldurchlass Cable outlet	Rot Red	Blau Blue	Grün Green
8	4–6 mm	99 0771 401 08	8	4–6 mm	99 0771 451 08	99 0771 461 08	99 0771 471 08

Polzahl	8	Number of contacts
Steckverbinder Verriegelung	Bajonett/bayonet	Connector locking system
Anschlussart	löten/solder	Termination
Anschlussquerschnitt	0,25 mm ² (AWG 24)	Wire gauge
Kabeldurchlass	2,5–4 mm, 4–6 mm, 6–8 mm	Cable outlet
Schutzart	IP67	Degree of protection
Mechanische Lebensdauer	> 5000 Steckzyklen/> 5000 mating cycles	Mechanical operation
Obere Grenztemperatur	+ 85 °C	Upper temperature
Untere Grenztemperatur	– 25 °C	Lower temperature
Bemessungsspannung	175 V	Rated voltage
Bemessungs-Stoßspannung	1750 V	Rated impulse voltage
Verschmutzungsgrad	2	Pollution degree
Überspannungskategorie	II	Overvoltage categorie
Isolierstoffgruppe	II	Material group
Bemessungsstrom (40°C)	2 A	Rated current (40 °C)
Material Kontakt	CuZn (Messing/brass)	Material of contact
Kontaktoberfläche	Au (Gold/gold)	Contact plating
Material Kontaktkörper	PA	Material of contact body
Material Gehäuse	PA	Material of housing
Material Verriegelung	PA	Material of locking

Kabelstecker, weiß
Male cable connector, white

Kabelstecker, rot, blau, grün
Male cable connector, red, blue, green

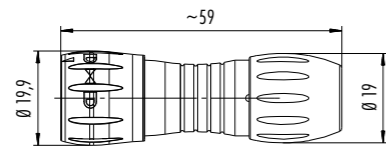

Polzahl Contacts	Kabeldurchlass Cable outlet	Bestell-Nr. Ordering-No.	Polzahl Contacts	Kabeldurchlass Cable outlet	Rot Red	Blau Blue	Grün Green
8	6–8 mm	99 0771 402 08	8	2,5–4 mm	99 0771 452 08	99 0771 462 08	99 0771 472 08

Polzahl	8	Number of contacts
Steckverbinder Verriegelung	Bajonett/bayonet	Connector locking system
Anschlussart	löten/solder	Termination
Anschlussquerschnitt	0,25 mm ² (AWG 24)	Wire gauge
Kabeldurchlass	2,5–4 mm, 4–6 mm, 6–8 mm	Cable outlet
Schutzart	IP67	Degree of protection
Mechanische Lebensdauer	> 5000 Steckzyklen/> 5000 mating cycles	Mechanical operation
Obere Grenztemperatur	+ 85 °C	Upper temperature
Untere Grenztemperatur	- 25 °C	Lower temperature
Bemessungsspannung	175 V	Rated voltage
Bemessungs-Stoßspannung	1750 V	Rated impulse voltage
Verschmutzungsgrad	2	Pollution degree
Überspannungskategorie	II	Overvoltage categorie
Isolierstoffgruppe	II	Material group
Bemessungsstrom (40 °C)	2 A	Rated current (40 °C)
Material Kontakt	CuZn (Messing/brass)	Material of contact
Kontaktoberfläche	Au (Gold/gold)	Contact plating
Material Kontaktkörper	PA	Material of contact body
Material Gehäuse	PA	Material of housing
Material Verriegelung	PA	Material of locking

Flanschdose, löten, weiß
Female panel mount connector,
solder, white

Flanschdose, löten, rot
Female panel mount connector,
solder, red

Flanschdose, löten, blau
Female panel mount connector,
solder, blue

Flanschdose, löten, grün
Female panel mount connector,
solder, green

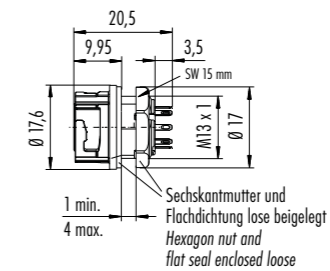

Polzahl Contacts	Bestell-Nr. Ordering-No.	Polzahl Contacts	Bestell-Nr. Ordering-No.	Polzahl Contacts	Bestell-Nr. Ordering-No.	Polzahl Contacts	Bestell-Nr. Ordering-No.
8	09 0774 400 08	8	09 0774 450 08	8	09 0774 460 08	8	09 0774 470 08

Polzahl	8	Number of contacts
Steckverbinder Verriegelung	Bajonett/bayonet	Connector locking system
Anschlussart	löten/solder	Termination
Anschlussquerschnitt	0,25 mm ² (AWG 24)	Wire gauge
Kabeldurchlass	—	Cable outlet
Schutzart	IP67 auch ungesteckt/also when not mated	Degree of protection
Mechanische Lebensdauer	> 5000 Steckzyklen/> 5000 mating cycles	Mechanical operation
Obere Grenztemperatur	+ 85 °C	Upper temperature
Untere Grenztemperatur	- 25 °C	Lower temperature
Bemessungsspannung	175 V	Rated voltage
Bemessungs-Stoßspannung	1750 V	Rated impulse voltage
Verschmutzungsgrad	2	Pollution degree
Überspannungskategorie	II	Overvoltage categorie
Isolierstoffgruppe	II	Material group
Bemessungsstrom (40 °C)	2 A	Rated current (40 °C)
Material Kontakt	CuSn (Bronze/bronze)	Material of contact
Kontaktoberfläche	Au (Gold/gold)	Contact plating
Material Kontaktkörper	PA	Material of contact body
Material Gehäuse	PA	Material of housing
Material Verriegelung	—	Material of locking

Flanschdose, löten, von vorn verschraubbar, weiß
Female panel mount connector, solder, front fastened, white



Flanschdose, löten, von vorn verschraubbar, rot
Female panel mount connector, solder, front fastened, red



Flanschdose, löten, von vorn verschraubbar, blau
Female panel mount connector, solder, front fastened, blue



Flanschdose, löten, von vorn verschraubbar, grün
Female panel mount connector, solder, front fastened, green

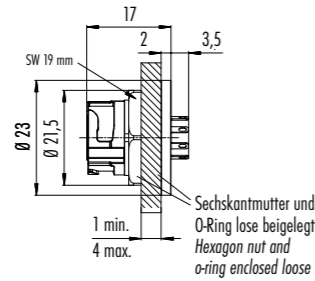

Polzahl Contacts	Bestell-Nr. Ordering-No.	Polzahl Contacts	Bestell-Nr. Ordering-No.	Polzahl Contacts	Bestell-Nr. Ordering-No.	Polzahl Contacts	Bestell-Nr. Ordering-No.
8	09 0774 580 08	8	09 0774 585 08	8	09 0774 586 08	8	09 0774 587 08

Polzahl	8	Number of contacts
Steckverbinder Verriegelung	Bajonett/bayonet	Connector locking system
Anschlussart	löten/solder	Termination
Anschlussquerschnitt	0,25 mm ² (AWG 24)	Wire gauge
Kabeldurchlass	—	Cable outlet
Schutzart	IP67 auch ungesteckt/also when not mated	Degree of protection
Mechanische Lebensdauer	> 5000 Steckzyklen/> 5000 mating cycles	Mechanical operation
Obere Grenztemperatur	+ 85 °C	Upper temperature
Untere Grenztemperatur	- 25 °C	Lower temperature
Bemessungsspannung	175 V	Rated voltage
Bemessungs-Stoßspannung	1750 V	Rated impulse voltage
Verschmutzungsgrad	2	Pollution degree
Überspannungskategorie	II	Overvoltage categorie
Isolierstoffgruppe	II	Material group
Bemessungsstrom (40°C)	2 A	Rated current (40 °C)
Material Kontakt	CuSn (Bronze/bronze)	Material of contact
Kontaktoberfläche	Au (Gold/gold)	Contact plating
Material Kontaktkörper	PA	Material of contact body
Material Gehäuse	PA	Material of housing
Material Verriegelung	—	Material of locking

Flanschdose, tauchlöten, weiß
Female panel mount connector, dip solder, white



Bohrbild siehe Seite 41
Drilling scheme see page 41

Flanschdose, tauchlöten, rot
Female panel mount connector, dip solder, red



Bohrbild siehe Seite 41
Drilling scheme see page 41

Flanschdose, tauchlöten, blau
Female panel mount connector, dip solder, blue



Bohrbild siehe Seite 41
Drilling scheme see page 41

Flanschdose, tauchlöten, grün
Female panel mount connector, dip solder, green



Bohrbild siehe Seite 41
Drilling scheme see page 41

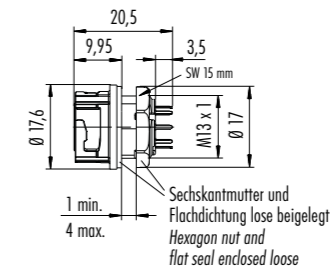

Polzahl Contacts	Bestell-Nr. Ordering-No.	Polzahl Contacts	Bestell-Nr. Ordering-No.	Polzahl Contacts	Bestell-Nr. Ordering-No.	Polzahl Contacts	Bestell-Nr. Ordering-No.
8	09 0774 490 08	8	09 0774 495 08	8	09 0774 496 08	8	09 0774 497 08

Polzahl	8	Number of contacts
Steckverbinder Verriegelung	Bajonett/bayonet	Connector locking system
Anschlussart	tauchlöten/dip solder	Termination
Anschlussquerschnitt	—	Wire gauge
Kabeldurchlass	—	Cable outlet
Schutzart	IP67 auch ungesteckt/also when not mated	Degree of protection
Mechanische Lebensdauer	> 5000 Steckzyklen/> 5000 mating cycles	Mechanical operation
Obere Grenztemperatur	+ 85 °C	Upper temperature
Untere Grenztemperatur	- 25 °C	Lower temperature
Bemessungsspannung	175 V	Rated voltage
Bemessungs-Stoßspannung	1750 V	Rated impulse voltage
Verschmutzungsgrad	2	Pollution degree
Überspannungskategorie	II	Overvoltage categorie
Isolierstoffgruppe	II	Material group
Bemessungsstrom (40°C)	2 A	Rated current (40 °C)
Material Kontakt	CuSn (Bronze/bronze)	Material of contact
Kontaktoberfläche	Au (Gold/gold)	Contact plating
Material Kontaktkörper	PA	Material of contact body
Material Gehäuse	PA	Material of housing
Material Verriegelung	—	Material of locking

Flanschdose, tauchlöten, von vorn verschraubbar, weiß
Female panel mount connector, dip solder, front fastened, white



Bohrbild siehe Seite 41
Drilling scheme see page 41

Flanschdose, tauchlöten, von vorn verschraubbar, rot
Female panel mount connector, dip solder, front fastened, red



Bohrbild siehe Seite 41
Drilling scheme see page 41

Flanschdose, tauchlöten, von vorn verschraubbar, blau
Female panel mount connector, dip solder, front fastened, blue



Bohrbild siehe Seite 41
Drilling scheme see page 41

Flanschdose, tauchlöten, von vorn verschraubbar, grün
Female panel mount connector, dip solder, front fastened, green



Bohrbild siehe Seite 41
Drilling scheme see page 41

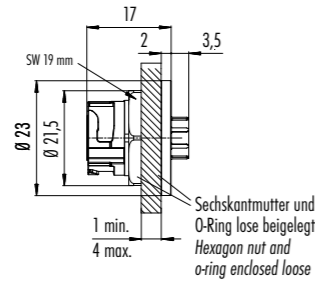

Polzahl Contacts	Bestell-Nr. Ordering-No.	Polzahl Contacts	Bestell-Nr. Ordering-No.	Polzahl Contacts	Bestell-Nr. Ordering-No.	Polzahl Contacts	Bestell-Nr. Ordering-No.
8	09 0774 590 08	8	09 0774 595 08	8	09 0774 596 08	8	09 0774 597 08

Polzahl	8	Number of contacts
Steckverbinder Verriegelung	Bajonett/bayonet	Connector locking system
Anschlussart	tauchlöten/dip solder	Termination
Anschlussquerschnitt	—	Wire gauge
Kabeldurchlass	—	Cable outlet
Schutzart	IP67 auch ungesteckt/also when not mated	Degree of protection
Mechanische Lebensdauer	> 5000 Steckzyklen/> 5000 mating cycles	Mechanical operation
Obere Grenztemperatur	+ 85 °C	Upper temperature
Untere Grenztemperatur	- 25 °C	Lower temperature
Bemessungsspannung	175 V	Rated voltage
Bemessungs-Stoßspannung	1750 V	Rated impulse voltage
Verschmutzungsgrad	2	Pollution degree
Überspannungskategorie	II	Overvoltage categorie
Isolierstoffgruppe	II	Material group
Bemessungsstrom (40°C)	2 A	Rated current (40 °C)
Material Kontakt	CuSn (Bronze/bronze)	Material of contact
Kontaktoberfläche	Au (Gold/gold)	Contact plating
Material Kontaktkörper	PA	Material of contact body
Material Gehäuse	PA	Material of housing
Material Verriegelung	—	Material of locking

Montageanleitung
Assembly instruction

1. Abmanteln auf L = 9 mm. Ummantelung abstreifen.
2. Druckschraube, Klemmkorb, Dichtring und Abstandshülse auf Kabel auffädeln.
3. Litzen abisolieren (L = 3 mm) und verzinnen.
4. Einsätze einlöten.
5. Bajonettadapter am Gewinde der Abstandshülse aufsetzen und mit leichtem Druck in Pfeilrichtung festschrauben.
6. Den Klemmkorb über den Dichtring bis auf Anschlag aufschieben.
7. Mit Druckschraube Klemm-, Dichteinheit gegen Abstandshülse drücken und festschrauben.

1. Strip to 9 mm length and take off the cable jacket.
2. Bead pressing screw, pinch ring, seal and distance sleeve to cable.
3. Strip the insulation off the wires (L = 3 mm) and tin them.
4. Solder inserts.
5. Put bayonet adapter to the thread of the distance sleeve and screw it with slight pressure in the direction of the arrow.
6. Push pinch ring over sealing ring to block.
7. Push pressing screw together with clamp-sealing unit towards distance sleeve and screw tightly.

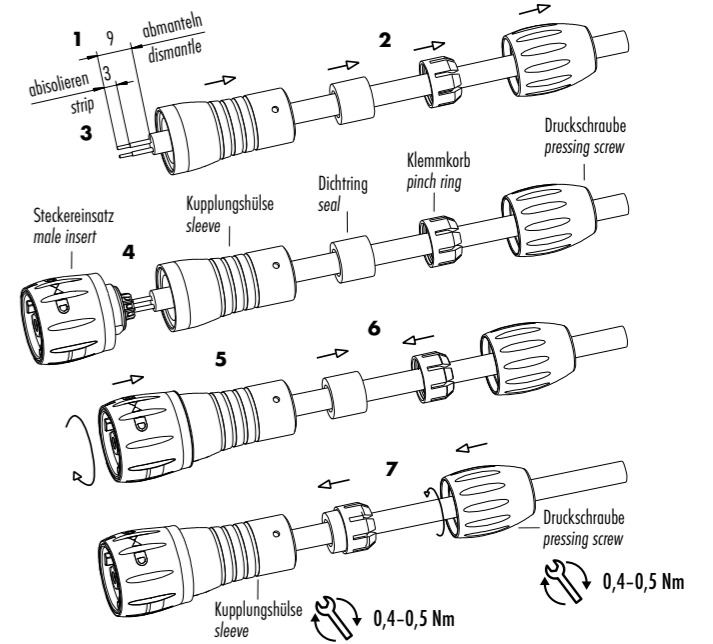

Einzelteildarstellung
Component part drawing

Flanschdose, löten
Female panel mount connector, solder

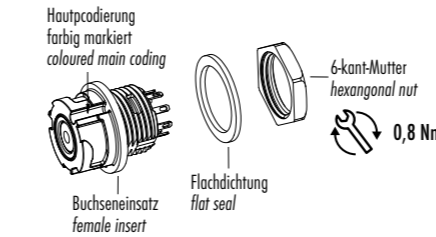

Flanschdose, tauchlöten
Female panel mount connector, dip solder

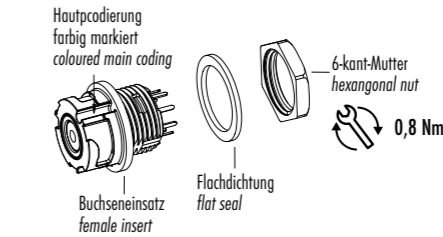

Flanschdosen, von vorn verschraubbar
Female panel mount connectors, front fastened

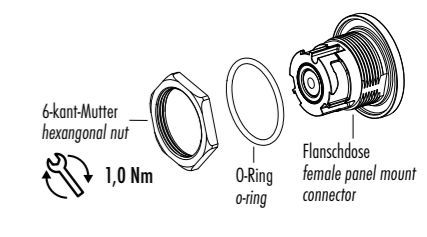

Polbilder
Contact arrangements

8 pol
8 contacts

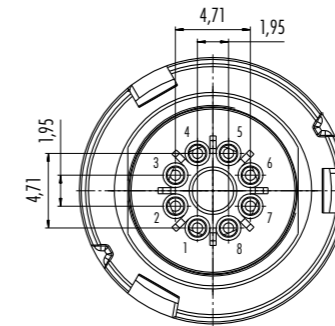

Stifteinsatz (Anschlussseite)
Male insert (termination side)

Buchseinsatz (Anschlussseite)
Female insert (termination side)

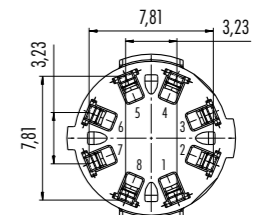

8 pol
8 contacts

Bohrbilder Stifteinsatz (Leiterplatte)
Drilling schemes male insert (PCB)

Bohrbilder Buchseinsatz (Leiterplatte)
Drilling schemes female insert (PCB)

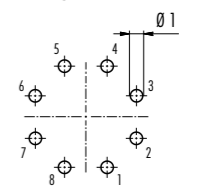

Montageausschnitt
Panel cut out

Flanschsteckverbinder
Panel mount connectors

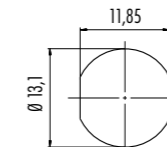

Flanschsteckverbinder, von vorn verschraubbar
Panel mount connectors, front fastened

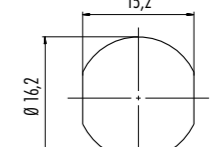



„Wir sind ein erfolgreiches Familienunternehmen.“

Zitat Markus Binder



„We are a successful family-run business.“

Quote Markus Binder





**Franz Binder GmbH & Co.
Elektrische Bauelemente KG**

Rötelstraße 27
74172 Neckarsulm
Deutschland / Germany

Tel. +49 7132 325-0
Fax +49 7132 325-190

vk@binder-connector.de
www.binder-connector.com

04/2024

