

Kabelstecker  
Male cable connector

Kabelstecker, rot, blau, grün  
Male cable connector, red, blue, green

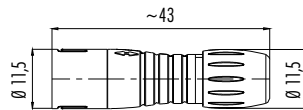

Polzahl Contacts	Kabeldurchlass max. Max. cable outlet	Bestell-Nr. Ordering-No.	Polzahl Contacts	Kabel-Ø max. Max. cable Ø	Rot Red	Blau Blue	Grün Green
3	3,5–5 mm	99 9205 400 03	3	3,5–5 mm	99 9205 450 03	99 9205 460 03	99 9205 470 03
4	3,5–5 mm	99 9209 400 04	4	3,5–5 mm	99 9209 450 04	99 9209 460 04	99 9209 470 04
5	3,5–5 mm	99 9213 400 05	5	3,5–5 mm	99 9213 450 05	99 9213 460 05	99 9213 470 05
8	3,5–5 mm	99 9225 400 08	8	3,5–5 mm	99 9225 450 08	99 9225 460 08	99 9225 470 08

Polzahl	3	4	5	8	Number of contacts
Steckverbinder Verriegelung	schnapp/snap-in				Connector locking system
Anschlussart	löten/solder				Termination
Anschlussquerschnitt	max. 0,25 mm <sup>2</sup> (max. AWG 24)				Wire gauge
Kabeldurchlass	3,5–5 mm				Cable outlet
Schutzart	IP67				Degree of protection
Mechanische Lebensdauer	> 500 Steckzyklen/> 500 mating cycles				Mechanical operation
Obere Grenztemperatur	+ 85 °C				Upper temperature
Untere Grenztemperatur	– 25 °C				Lower temperature
Bemessungsspannung	125 V			63 V	Rated voltage
Bemessungs-Stoßspannung	1500 V			800 V	Rated impulse voltage
Verschmutzungsgrad	2				Pollution degree
Überspannungskategorie	II				Overvoltage categorie
Isolierstoffgruppe	II				Material group
Bemessungsstrom (40°C)	3 A	2,5 A	2 A	1 A	Rated current (40 °C)
Material Kontakt	CuZn (Messing/brass)				Material of contact
Kontaktoberfläche	Au (Gold/gold)				Contact plating
Material Kontaktkörper	PA				Material of contact body
Material Gehäuse	PA				Material of housing
Material Verriegelung	PA				Material of locking

Kabeldose  
Female cable connector

Kabeldose, rot, blau, grün  
Female cable connector, red, blue, green

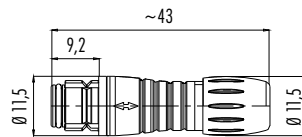

Polzahl Contacts	Kabeldurchlass max. Max. cable outlet	Bestell-Nr. Ordering-No.	Polzahl Contacts	Kabel-Ø max. Max. cable Ø	Rot Red	Blau Blue	Grün Green
3	3,5–5 mm	99 9206 400 03	3	3,5–5 mm	99 9206 450 03	99 9206 460 03	99 9206 470 03
4	3,5–5 mm	99 9210 400 04	4	3,5–5 mm	99 9210 450 04	99 9210 460 04	99 9210 470 04
5	3,5–5 mm	99 9214 400 05	5	3,5–5 mm	99 9214 450 05	99 9214 460 05	99 9214 470 05
8	3,5–5 mm	99 9226 400 08	8	3,5–5 mm	99 9226 450 08	99 9226 460 08	99 9226 470 08

Polzahl	3	4	5	8	Number of contacts
Steckverbinder Verriegelung	schnapp/snap-in				Connector locking system
Anschlussart	löten/solder				Termination
Anschlussquerschnitt	max. 0,25 mm <sup>2</sup> (max. AWG 24)				Wire gauge
Kabeldurchlass	3,5–5 mm				Cable outlet
Schutzart	IP67				Degree of protection
Mechanische Lebensdauer	> 500 Steckzyklen/> 500 mating cycles				Mechanical operation
Obere Grenztemperatur	+ 85 °C				Upper temperature
Untere Grenztemperatur	– 25 °C				Lower temperature
Bemessungsspannung	125 V			63 V	Rated voltage
Bemessungs-Stoßspannung	1500 V			800 V	Rated impulse voltage
Verschmutzungsgrad	2				Pollution degree
Überspannungskategorie	II				Overvoltage categorie
Isolierstoffgruppe	II				Material group
Bemessungsstrom (40°C)	3 A	2,5 A	2 A	1 A	Rated current (40 °C)
Material Kontakt	CuSn (Bronze/bronze)				Material of contact
Kontaktoberfläche	Au (Gold/gold)				Contact plating
Material Kontaktkörper	PA				Material of contact body
Material Gehäuse	PA				Material of housing
Material Verriegelung	PA				Material of locking

Flanschstecker  
Male panel mount connector

Flanschstecker, rot  
Male panel mount connector, red

Flanschstecker, blau  
Male panel mount connector, blue

Flanschstecker, grün  
Male panel mount connector, green

Flanschstecker, tauchlöten  
Male panel mount connector,  
dip solder



Bohrbilder siehe Seite 13  
Drilling schemes see page 13

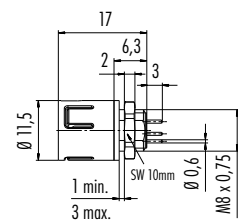
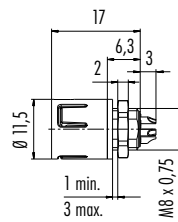

Polzahl Contacts	Bestell-Nr. Ordering-No.	Polzahl Contacts	Bestell-Nr. Ordering-No.	Polzahl Contacts	Bestell-Nr. Ordering-No.	Polzahl Contacts	Bestell-Nr. Ordering-No.	Polzahl Contacts	Bestell-Nr. Ordering-No.
3	99 9207 400 03	3	99 9207 050 03	3	99 9207 060 03	3	99 9207 070 03	3	99 9207 490 03
4	99 9211 400 04	4	99 9211 050 04	4	99 9211 060 04	4	99 9211 070 04	4	99 9211 490 04
5	99 9215 400 05	5	99 9215 050 05	5	99 9215 060 05	5	99 9215 070 05	5	99 9215 490 05
8	99 9227 400 08	8	99 9227 050 08	8	99 9227 060 08	8	99 9227 070 08	8	99 9227 490 08

Polzahl	3	4	5	8	Number of contacts
Steckverbinder Verriegelung	schnapp/snap-in				Connector locking system
Anschlussart	löten/tauchlöten/solder/dip solder				Termination
Anschlussquerschnitt	max. 0,25 mm <sup>2</sup> (max. AWG 24)/ —				Wire gauge
Kabeldurchlass	—				Cable outlet
Schutzart	IP67				Degree of protection
Mechanische Lebensdauer	> 500 Steckzyklen/> 500 mating cycles				Mechanical operation
Obere Grenztemperatur	+ 85 °C				Upper temperature
Untere Grenztemperatur	- 25 °C				Lower temperature
Bemessungsspannung	125 V			63 V	Rated voltage
Bemessungs-Stoßspannung	1500 V			800 V	Rated impulse voltage
Verschmutzungsgrad	2				Pollution degree
Überspannungskategorie	II				Overvoltage categorie
Isolierstoffgruppe	II				Material group
Bemessungsstrom (40°C)	3 A	2,5 A	2 A	1 A	Rated current (40 °C)
Material Kontakt	CuZn (Messing/brass)				Material of contact
Kontaktoberfläche	Au (Gold/gold)				Contact plating
Material Kontaktkörper	PA				Material of contact body
Material Gehäuse	PA				Material of housing
Material Verriegelung	—				Material of locking

Flanschdose  
Female panel mount connector



Flanschdose, rot  
Female panel mount connector, red



Flanschdose, blau  
Female panel mount connector, blue



Flanschdose, grün  
Female panel mount connector, green



Flanschdose, tauchlöten  
Female panel mount connector, dip solder



Bohrbilder siehe Seite 13  
Drilling schemes see page 13

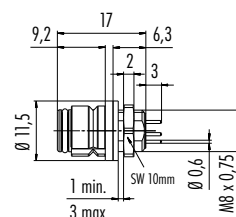
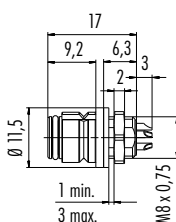

Polzahl Contacts	Bestell-Nr. Ordering-No.	Polzahl Contacts	Bestell-Nr. Ordering-No.	Polzahl Contacts	Bestell-Nr. Ordering-No.	Polzahl Contacts	Bestell-Nr. Ordering-No.	Polzahl Contacts	Bestell-Nr. Ordering-No.
3	99 9208 400 03	3	99 9208 050 03	3	99 9208 060 03	3	99 9208 070 03	3	99 9208 490 03
4	99 9212 400 04	4	99 9212 050 04	4	99 9212 060 04	4	99 9212 070 04	4	99 9212 490 04
5	99 9216 400 05	5	99 9216 050 05	5	99 9216 060 05	5	99 9216 070 05	5	99 9216 490 05
8	99 9228 400 08	8	99 9228 050 08	8	99 9228 060 08	8	99 9228 070 08	8	99 9228 490 08

Polzahl	3	4	5	8	Number of contacts
Steckverbinder Verriegelung	schnapp/snap-in				Connector locking system
Anschlussart	löten/tauchlöten/solder/dip solder				Termination
Anschlussquerschnitt	max. 0,25 mm <sup>2</sup> (max. AWG 24)/ —				Wire gauge
Kabeldurchlass	—				Cable outlet
Schutzart	IP67				Degree of protection
Mechanische Lebensdauer	> 500 Steckzyklen/> 500 mating cycles				Mechanical operation
Obere Grenztemperatur	+ 85 °C				Upper temperature
Untere Grenztemperatur	- 25 °C				Lower temperature
Bemessungsspannung	125 V			63 V	Rated voltage
Bemessungs-Stoßspannung	1500 V			800 V	Rated impulse voltage
Verschmutzungsgrad	2				Pollution degree
Überspannungskategorie	II				Overvoltage categorie
Isolierstoffgruppe	II				Material group
Bemessungsstrom (40°C)	3 A	2,5 A	2 A	1 A	Rated current (40 °C)
Material Kontakt	CuSn (Bronze/bronze)				Material of contact
Kontaktoberfläche	Au (Gold/gold)				Contact plating
Material Kontaktkörper	PA				Material of contact body
Material Gehäuse	PA				Material of housing
Material Verriegelung	—				Material of locking

Montageanleitung  
Assembly instruction

1. Abmanteln auf L = 12 mm.
2. Druckschraube, Klemmkorb, Dichtring und Kupplungshülse auf Kabel aufädeln.
3. O-Ring auf Kontakteinsatz aufziehen.
4. Litzen abisolieren und anlöten.
5. Kupplungshülse aufschrauben.
6. Druckschraube festdrehen.

1. Dismantle cable to 12 mm length.
2. Bead pressing screw, pinch ring, seal and sleeve to cable.
3. Fit O-ring on the contact insert.
4. Strip and solder single wires.
5. Screw on sleeve.
6. Tighten pressing screw.

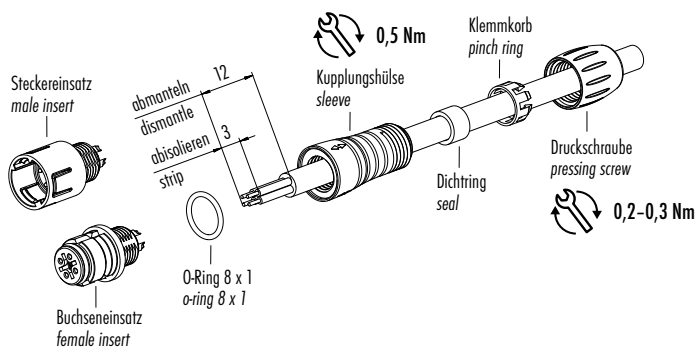

Einzelteildarstellung  
Component part drawing

Flanschsteckverbinder, löten  
Panel mount connectors, solder

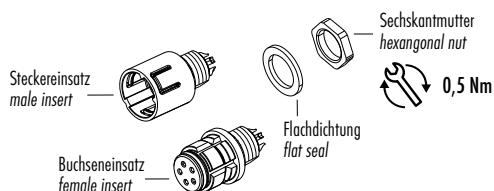

Flanschsteckverbinder, tauchlöten  
Panel mount connectors, dip solder

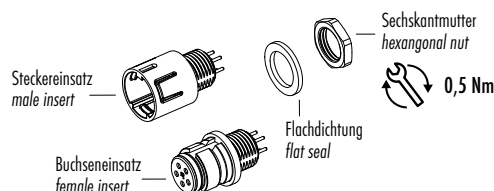

Montage Adapter  
Assembly of adapter

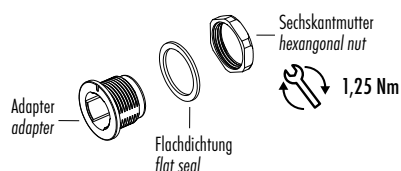

Montage Adapter, von vorn verschraubbar  
Assembly of adapter, front fastened

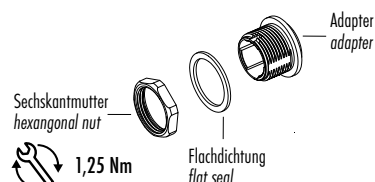

Adapter  
Adapter

Die Markierung des Adapters muss mit der Kodiernase des Einsatzes übereinstimmen  
The marking of the adapter must be conform with the coding nut of the insert

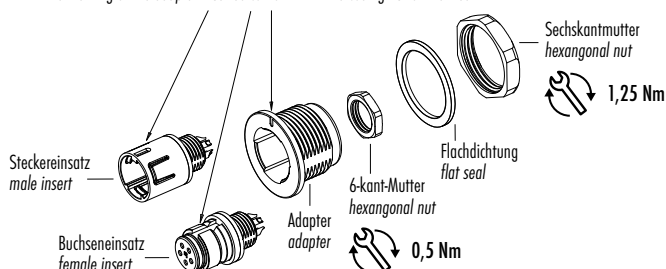

Einsätze müssen separat bestellt werden  
Inserts have to be ordered separately

Adapter, von vorn verschraubbar  
Adapter, front fastened

Die Markierung des Adapters muss mit der Kodiernase des Einsatzes übereinstimmen  
The marking of the adapter must be conform with the coding nut of the insert

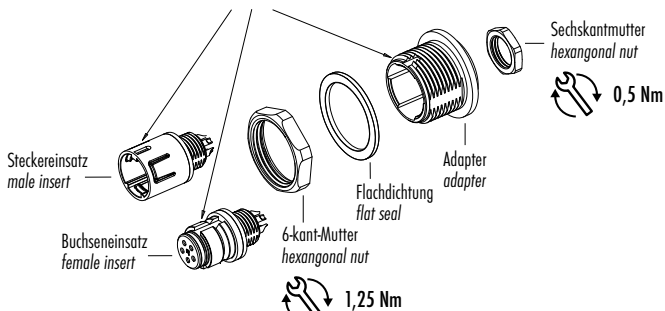

Einsätze müssen separat bestellt werden  
Inserts have to be ordered separately

Polbilder  
Contact arrangements

Stifteinsatz (Steckseite)  
Male insert (mating side)

Buchseinsatz (Steckseite)  
Female insert (mating side)

3 pol  
3 contacts

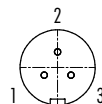
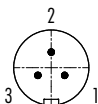

4 pol  
4 contacts

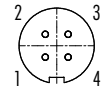

5 pol  
5 contacts

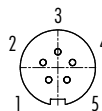
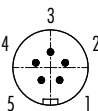

8 pol  
8 contacts

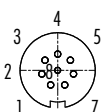
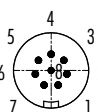

Bohrbilder Stifteinsatz (Leiterplatte)  
Drilling schemes male insert (PCB)

Bohrbilder Buchseinsatz (Leiterplatte)  
Drilling schemes female insert (PCB)

3 pol  
3 contacts

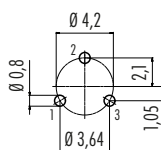
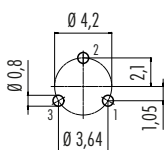

4 pol  
4 contacts

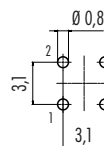
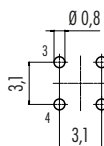

5 pol  
5 contacts

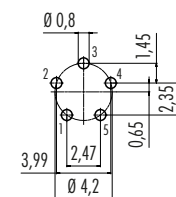
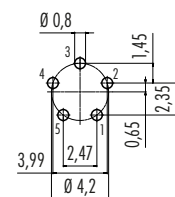

8 pol  
8 contacts

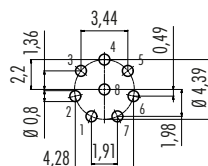
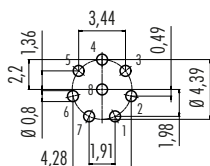

Montageausschnitt  
Panel cut out

Flanschsteckverbinder  
Panel mount connectors

Adapter  
Adapter

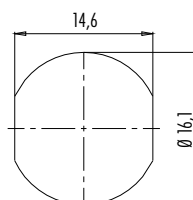
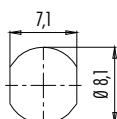

Bezeichnung / Description

Maßzeichnung / Drawing

Bestell-Nr. / Ordering-No.

Adapter für Flanschsteckverbinder  
 Adapter for panel mount connectors

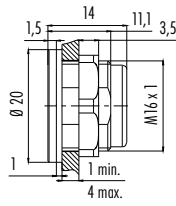

08 2636 400 001

Adapter für Flanschsteckverbinder,  
 von vorn verschraubt  
 Adapter for panel mount connectors,  
 front fastened

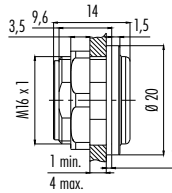

08 2629 400 001

Anwendungsbeispiel für Adapter  
 Example for use for adapter

Flanschstecker  
 Male panel mount connector



Flanschstecker mit Adapter  
 Male panel mount connector  
 with adapter



Flanschdose  
 Female panel mount connector



Flanschdose mit Adapter, von  
 vorn verschraubbar  
 Female panel mount connector  
 with adapter, front fastened

