



SUBMINIATUR
SUBMINIATURE

Bereich	Range	Serie Series	Seite Page	Schutzart Degree of protection	Spannung Voltage	Strom Current	Polzahl No. of contacts	EMV EMC	Ø in mm Ø in mm	Anschlussart Termination							am Kabel angespritzt moulded connectors	Verriegelung Locking			
										löten solder	tauchlöten dip solder	SMT SMT	Schrauben screw	crimpen crimp	Käfigzugfeder Wire clamp	Schneidklemm IDT		Schrauben screw	Bajonett Bayonet	schnapp snap-in	Push-Pull Push-Pull
Subminiatur Subminiature																					
Snap-in IP40	Snap-in IP40	719 · 709	4 – 11	IP40	60V	3 A	3–5	—	8–9	•719	•719						•709			•	
Snap-in IP67	Snap-in IP67	620	12 – 21	IP67	63/125V	1–3 A	3–8	—	11,5	•	•						•			•	
Bajonett NCC	Bayonet NCC	670	22 – 27	IP54	50V	2 A	5		16–17	•	•									•	
Bajonett	Bayonet	710	28 – 33	IP40	125V	1–4 A	2–8	—	12	•										•	
Push-Pull	Push-Pull	430	34 – 39	IP67/IP40	125V	1–4 A	3–8	•/—	14,5	•	•										•
M9 IP40	M9 IP40	711	40 – 47	IP40	125V	1–4 A	2–8	—	11,5	•	•							M9 x 0,5			
M9 IP67	M9 IP67	712 · 702	48 – 69	IP67	125V	1–4 A	2–8	•/—	11,5–14	•	•						•702	M9 x 0,5			

Übersicht Summary

Snap-in IP40

Serie 719 · 709

- Steckverbinder mit Schnappverriegelung
- Steckverbinder umspritzt am Kabel
- Ausführungen mit und ohne Zugentlastung
- Schutzart IP40
- Durchmesser oder Breite nur 9 mm
- 2 m und 5 m Kabellänge
- Einfache Montage

719 · 709 Series

- Connectors with snap-in locking
- Connectors moulded on cable
- Versions with and without strain relief
- Degree of protection IP40
- Diameter or breadth only 9 mm
- 2 m and 5 m cable length
- Easy assembly

Snap-in IP67

Serie 620

- Steckverbinder mit Schnappverriegelung
- Steckverbinder umspritzt am Kabel
- Schutzart IP67
- Innenliegende Zugentlastung
- Einfache Montage
- Versionen mit Farbkodierung

620 Series

- Connectors with snap-in locking
- Connectors moulded on cable
- Degree of protection IP67
- Internal strain relief
- Easy assembly
- Versions with colour-coding

Bajonett NCC

Serie 670

- Steckverbinder mit schneller Bajonett-Verriegelung
- Schutzart IP40
- Kabeldurchlass in 2 Größen
- Kabelverschraubung mit integrierter Zugentlastung
- Steckverbinder Durchmesser 12 mm

Bayonet NCC

670 Series

- Connectors with quick bayonet locking
- Degree of protection IP40
- Cable outlet in 2 sizes
- Cable housing with integrated strain relief
- Connector diameter 12 mm

Bajonett IP40

Serie 710

- Steckverbinder mit schneller Bajonett-Verriegelung
- Schutzart IP40
- Kabeldurchlass in 2 Größen
- Kabelverschraubung mit integrierter Zugentlastung
- Steckverbinder Durchmesser 12 mm

Bayonet IP40

710 Series

- Connectors with quick bayonet locking
- Degree of protection IP40
- Cable outlet in 2 sizes
- Cable housing with integrated strain relief
- Connector diameter 12 mm

Push-Pull IP67

Serie 430

- Steckverbinder mit Push-Pull Verriegelung
- Schutzart IP67/IP40
- Schirmbare Kabelsteckverbinder mit sehr guten EMV-Eigenschaften
- Kabeldurchlass 3,5–5 mm
- Druckschraube mit Vibrationsbremse

430 Series

- Connectors with push-pull locking
- Degree of protection IP67/IP40
- Shielded cable connectors with excellent EMC protection
- Cable outlet 3,5–5 mm
- Pressing screw with immunity to vibration

M9 IP40

Serie 711

- Steckverbinder mit Schraubverriegelung
- Schutzart IP40
- Kabeldurchlass in 2 Größen
- Kabelverschraubung mit integrierter Zugentlastung

711 Series

- Connectors with screw locking
- Degree of protection IP40
- Cable outlet in 2 sizes
- Cable housing with integrated strain relief

M9 IP67

Serie 712 · 702

- Steckverbinder mit Schraubverriegelung
- Steckverbinder umspritzt am Kabel
- Steckverbinder und Kabel 360° EMV-sicher geschirmt
- Metallgehäuse 360° EMV-sicher geschirmt
- Schutzart IP67
- 2 m und 5 m Kabellänge
- Einfache Montage

712 · 702 Series

- Connectors with screw locking
- Connectors moulded on cable
- Connectors and cable with 360° EMC protected shielding
- Metal housing with 360° EMC protected shielding
- Degree of protection IP67
- 2 m and 5 m cable length
- Easy assembly

Subminiatur

Subminiature



Snap-in IP40 Subminiatur

Snap-in IP40 Subminiature

Kabelsteckverbinder

- Snap-in-Verriegelung
- 3 – 5-polig
- Schutzart IP40 ¹⁾
- Lötanschluss
- Am Kabel angespritzte Ausführungen
- Einfache Montage

Flanschsteckverbinder

- Snap-in-Verriegelung
- 3 – 5-polig
- Schutzart IP40 ¹⁾
- Löt-/Tauchlötanschluss

Cable Connectors

- Snap-in locking system
- 3 – 5 contacts
- Degree of protection IP40 ¹⁾
- Solder termination
- Moulded versions
- Easy assembly

Panel Mount Connectors

- Snap-in locking system
- 3 – 5 contacts
- Degree of protection IP40 ¹⁾
- Solder/dip solder termination

Kabelstecker ohne Zugentlastung
Male cable connector without strain relief

Kabelstecker mit Zugentlastung
Male cable connector with strain relief

Kabeldose ohne Zugentlastung
Female cable connector without strain relief

Kabeldose mit Zugentlastung
Female cable connector with strain relief



Polzahl Contacts	Kabel-Ø max. Max. cable Ø	Bestell-Nr. Ordering-No.	Polzahl Contacts	Kabel-Ø max. Max. cable Ø	Bestell-Nr. Ordering-No.	Polzahl Contacts	Kabel-Ø max. Max. cable Ø	Bestell-Nr. Ordering-No.	Polzahl Contacts	Kabel-Ø max. Max. cable Ø	Bestell-Nr. Ordering-No.
3	3,6 mm	09 9747 00 03	3	3-4 mm	09 9747 70 03	3	3,6 mm	09 9748 00 03	3	3-4 mm	09 9748 70 03
				4-5 mm	09 9747 71 03					4-5 mm	09 9748 71 03
4	3,6 mm	09 9767 00 04	4	3-4 mm	09 9767 70 04	4	3,6 mm	09 9764 00 04	4	3-4 mm	09 9764 70 04
				4-5 mm	09 9767 71 04					4-5 mm	09 9764 71 04
5	3,6 mm	09 9789 00 05	5	3-4 mm	09 9789 70 05	5	3,6 mm	09 9790 00 05	5	3-4 mm	09 9790 70 05
				4-5 mm	09 9789 71 05					4-5 mm	09 9790 71 05

Polzahl	3	4	5	Number of contacts
Steckverbinder Verriegelung	schnapp/snap-in			Connector locking system
Anschlussart	löten/solder			Termination
Anschlussquerschnitt	max. 0,25 mm ² (max. AWG 24)			Wire gauge
Kabeldurchlass	3-5 mm			Cable outlet
Schutzart	IP40			Degree of protection
Mechanische Lebensdauer	> 100 Steckzyklen/> 100 mating cycles			Mechanical operation
Obere Grenztemperatur	+ 70 °C			Upper temperature
Untere Grenztemperatur	- 25 °C			Lower temperature
Bemessungsspannung	60 V			Rated voltage
Bemessungs-Stoßspannung	800 V			Rated impulse voltage
Verschmutzungsgrad	1			Pollution degree
Überspannungskategorie	II			Overvoltage categorie
Isolierstoffgruppe	III			Material group
Bemessungsstrom (40 °C)	3 A			Rated current (40 °C)
Material Kontakt	Stift/pin CuZn (Messing/brass), Buchse/socket CuSn (Bronze/bronze)			Material of contact
Kontaktoberfläche	Au (Gold/gold)			Contact plating
Material Kontaktkörper	PA			Material of contact body
Material Gehäuse	PA			Material of housing
Material Verriegelung	—			Material of locking

Flanschstecker Lötanschluss
Male panel mount connector,
solder termination

Flanschstecker Tauchlötanschluss
Male panel mount connector,
dip solder termination

Flanschdose Lötanschluss
Female panel mount connector,
solder termination

Flanschdose Tauchlötanschluss
Female panel mount connector,
dip solder termination

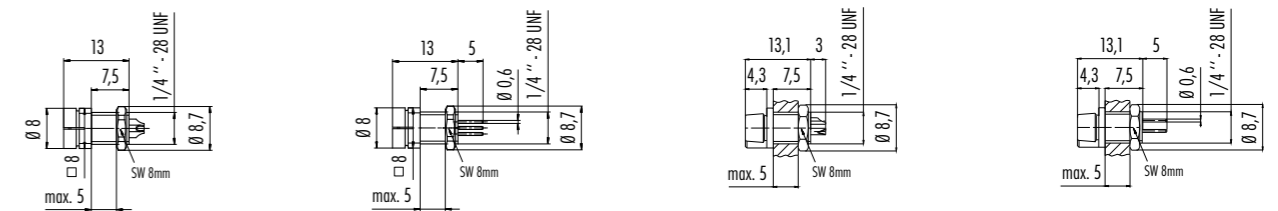

Polzahl Contacts	Bestell-Nr. Ordering-No.	Polzahl Contacts	Bestell-Nr. Ordering-No.	Polzahl Contacts	Bestell-Nr. Ordering-No.	Polzahl Contacts	Bestell-Nr. Ordering-No.
3	09 9749 30 03	3	09 9749 20 03	3	09 9750 30 03	3	09 9750 20 03
4	09 9765 30 04	4	09 9765 20 04	4	09 9766 30 04	4	09 9766 20 04
5	09 9791 30 05	5	09 9791 20 05	5	09 9792 30 05	5	09 9792 20 05

Polzahl	3	4	5	Number of contacts
Steckverbinder Verriegelung	schnapp/snap-in			Connector locking system
Anschlussart	löten, tauchlöten/solder, dip solder			Termination
Anschlussquerschnitt	max. 0,25 mm ² (max. AWG 24)			Wire gauge
Kabeldurchlass	—			Cable outlet
Schutzart	IP40			Degree of protection
Mechanische Lebensdauer	> 100 Steckzyklen/> 100 mating cycles			Mechanical operation
Obere Grenztemperatur	+ 70 °C			Upper temperature
Untere Grenztemperatur	- 25 °C			Lower temperature
Bemessungsspannung	60 V			Rated voltage
Bemessungs-Stoßspannung	800 V			Rated impulse voltage
Verschmutzungsgrad	1			Pollution degree
Überspannungskategorie	II			Overvoltage categorie
Isolierstoffgruppe	III			Material group
Bemessungsstrom (40 °C)	3 A			Rated current (40 °C)
Material Kontakt	Stift/pin CuZn (Messing/brass), Buchse/socket CuSn (Bronze/bronze)			Material of contact
Kontaktoberfläche	Au (Gold/gold)			Contact plating
Material Kontaktkörper	PA			Material of contact body
Material Gehäuse	PA			Material of housing
Material Verriegelung	—			Material of locking

Kabelstecker umspritzt
Male cable connector moulded



Winkelstecker umspritzt
Male angled connector moulded

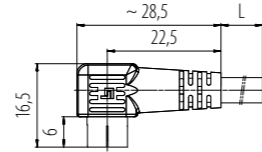
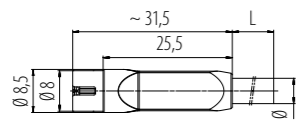

Polzahl Contacts	Kabellänge 2 m Cable length 2 m	Kabellänge 5 m Cable length 5 m	Polzahl Contacts	Kabellänge 2 m Cable length 2 m	Kabellänge 5 m Cable length 5 m
3	77 7095 0000 10003-0200	77 7095 0000 10003-0500	3	77 7093 0000 10003-0200	77 7093 0000 10003-0500
4	77 7095 0000 10004-0200	77 7095 0000 10004-0500	4	77 7093 0000 10004-0200	77 7093 0000 10004-0500
5	77 7095 0000 10005-0200	77 7095 0000 10005-0500	5	77 7093 0000 10005-0200	77 7093 0000 10005-0500

Technische Daten Kabel	3	4	5	Specifications of cable
Querschnitt mm ² ¹⁾	3 x 0,25 mm ² (AWG 24)	4 x 0,25 mm ² (AWG 24)	5 x 0,25 mm ² (AWG 24)	Wire gauge mm ² ¹⁾
Material Mantel	PVC			Material jacket
Isolation Litze	PVC			Insulation wire
Litzenaufbau (mm)	32 x 0,1		14 x 0,15	Design of wire (mm)
Kabelmantel Ø (mm)	4,5 ±0,2	4,5 ±0,2	5 ±0,2	Cable jacket Ø (mm)
Leiterwiderstand	80 Ω/Km (20 °C)			Resistance of wire
Temp.-Bereich (Kabel bew.)	- 5 °C /+ 70 °C			Temp. range (cable in move)
Temp.-Bereich (Kabel fest)	- 25 °C /+ 70 °C			Temp. range (cable fixed)
Biegeradius (Kabel bew.)	45 mm		50 mm	Bending radius (cable in move)
Biegeradius (Kabel fest)	22 mm		25 mm	Bending radius (cable fixed)
Zulassung	—			Approval

Polzahl	3	4	5	Number of contacts
Steckverbinder Verriegelung	schnapp/snap-in			Connector locking system
Anschlussart	am Kabel angespritzt/moulded			Termination
Anschlussquerschnitt	0,25 mm ² (AWG 24)			Wire gauge
Kabeldurchlass	—			Cable outlet
Schutzart	IP40			Degree of protection
Mechanische Lebensdauer	> 100 Steckzyklen/> 100 mating cycles			Mechanical operation
Obere Grenztemperatur	+ 70 °C			Upper temperature
Untere Grenztemperatur	- 25 °C			Lower temperature
Bemessungsspannung	60 V			Rated voltage
Bemessungs-Stoßspannung	800 V			Rated impulse voltage
Verschmutzungsgrad	1			Pollution degree
Überspannungskategorie	II			Overvoltage categorie
Isolierstoffgruppe	III			Material group
Bemessungsstrom (40°C)	3 A			Rated current (40 °C)
Material Kontakt	(Messing/brass)			Material of contact
Kontaktoberfläche	Au (Gold/gold)			Contact plating
Material Kontaktkörper	PA			Material of contact body
Material Gehäuse	PUR			Material of housing
Material Verriegelung	—			Material of locking

¹⁾ Vergleichbare AWG Leiter siehe technische Informationen./ ¹⁾ Comparable AWG conductors see technical information.

Kabeldose umspritzt
Female cable connector moulded



Winkeldose umspritzt
Female angled connector moulded

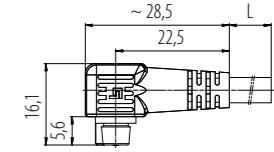
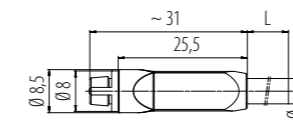

Polzahl Contacts	Kabellänge 2 m Cable length 2 m	Kabellänge 5 m Cable length 5 m	Polzahl Contacts	Kabellänge 2 m Cable length 2 m	Kabellänge 5 m Cable length 5 m
3	77 7096 0000 10003-0200	77 7096 0000 10003-0500	3	77 7098 0000 10003-0200	77 7098 0000 10003-0500
4	77 7096 0000 10004-0200	77 7096 0000 10004-0500	4	77 7098 0000 10004-0200	77 7098 0000 10004-0500
5	77 7096 0000 10005-0200	77 7096 0000 10005-0500	5	77 7098 0000 10005-0200	77 7098 0000 10005-0500

Technische Daten Kabel	3	4	5	Specifications of cable
Querschnitt mm ² ¹⁾	3 x 0,25 mm ² (AWG 24)	4 x 0,25 mm ² (AWG 24)	5 x 0,25 mm ² (AWG 24)	Wire gauge mm ² ¹⁾
Material Mantel	PVC			Material jacket
Isolation Litze	PVC			Insulation wire
Litzenaufbau (mm)	32 x 0,1		14 x 0,15	Design of wire (mm)
Kabelmantel Ø (mm)	4,5 ±0,2	4,5 ±0,2	5 ±0,2	Cable jacket Ø (mm)
Leiterwiderstand	80 Ω/Km (20 °C)			Resistance of wire
Temp.-Bereich (Kabel bew.)	- 5 °C /+ 70 °C			Temp. range (cable in move)
Temp.-Bereich (Kabel fest)	- 25 °C /+ 70 °C			Temp. range (cable fixed)
Biegeradius (Kabel bew.)	45 mm		50 mm	Bending radius (cable in move)
Biegeradius (Kabel fest)	22 mm		25 mm	Bending radius (cable fixed)
Zulassung	—			Approval

Polzahl	3	4	5	Number of contacts
Steckverbinder Verriegelung	schnapp/snap-in			Connector locking system
Anschlussart	am Kabel angespritzt/moulded			Termination
Anschlussquerschnitt	0,25 mm ² (AWG 24)			Wire gauge
Kabeldurchlass	—			Cable outlet
Schutzart	IP40			Degree of protection
Mechanische Lebensdauer	> 100 Steckzyklen/> 100 mating cycles			Mechanical operation
Obere Grenztemperatur	+ 70 °C			Upper temperature
Untere Grenztemperatur	- 25 °C			Lower temperature
Bemessungsspannung	60 V			Rated voltage
Bemessungs-Stoßspannung	800 V			Rated impulse voltage
Verschmutzungsgrad	1			Pollution degree
Überspannungskategorie	II			Overvoltage categorie
Isolierstoffgruppe	III			Material group
Bemessungsstrom (40°C)	3 A			Rated current (40 °C)
Material Kontakt	CuSn (Bronze/bronze)			Material of contact
Kontaktoberfläche	Au (Gold/gold)			Contact plating
Material Kontaktkörper	PA			Material of contact body
Material Gehäuse	PUR			Material of housing
Material Verriegelung	—			Material of locking

¹⁾ Vergleichbare AWG Leiter siehe technische Informationen./ ¹⁾ Comparable AWG conductors see technical information.

Montageanleitung
Assembly instruction

Kabelsteckverbinder ohne Zugentlastung
Cable connector without strain relief

1. Kupplungshülse auf Kabel auffädeln.
2. Kabel abmanteln auf L = 9 mm.
3. Litzen abisolieren und anlöten.
4. Kupplungshülse aufschrauben.

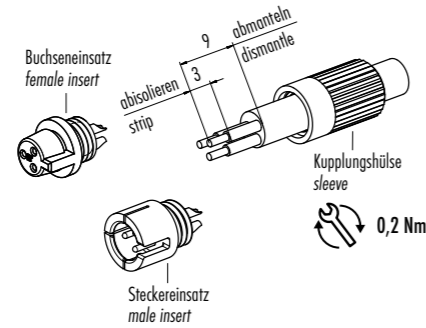

1. Bead sleeve to cable.
2. Dismantle cable to 9 mm length.
3. Strip and solder single wires.
4. Screw on sleeve.

Kabelsteckverbinder mit Zugentlastung
Cable connector with strain relief

1. Druckschraube und Klemmhülse auf Kabel auffädeln.
2. Kabel abmanteln auf L = 9 mm.
3. Litzen abisolieren und anlöten.
4. Klemmhülse aufschrauben.
5. Druckschraube festziehen.

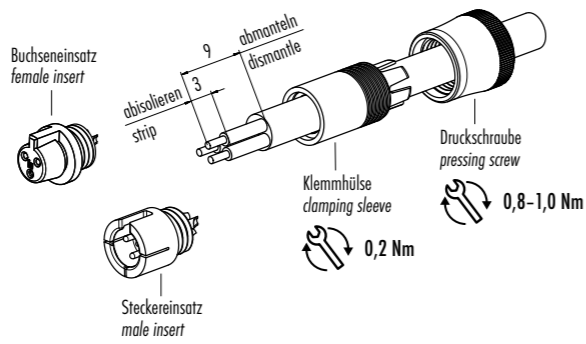

1. Bead pressing screw and clamping sleeve to cable.
2. Dismantle cable to 9 mm length.
3. Strip and solder single wires.
4. Screw on clamping sleeve.
5. Tighten pressing screw.

Einzelteildarstellung
Component part drawing

Flanschstecker, löten
Male panel mount connector, solder

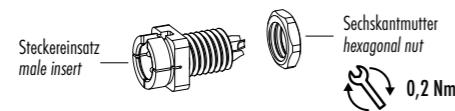

Flanschdose, löten
Female panel mount connector, solder

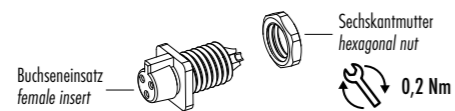

Flanschsteckverbinder, tauchlöten
Panel mount connectors, dip solder

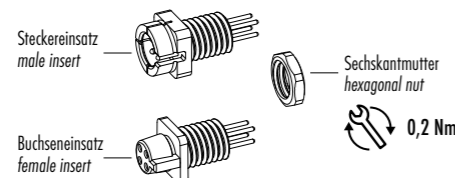

Polbilder
Contact arrangements

Stifteinsatz (Steckseite)
Male insert (mating side)

Buchseinsatz (Steckseite)
Female insert (mating side)

3 pol
3 contacts

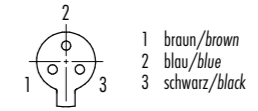
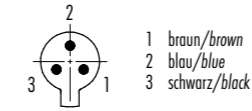

4 pol
4 contacts

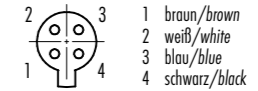
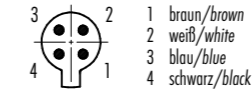

5 pol
5 contacts

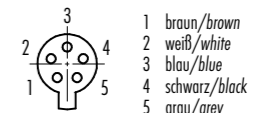
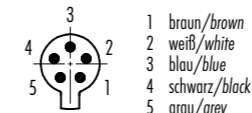

Bohrbilder Stifteinsatz (Leiterplatte)
Drilling schemes male insert (PCB)

Bohrbilder Buchseinsatz (Leiterplatte)
Drilling schemes female insert (PCB)

3 pol
3 contacts

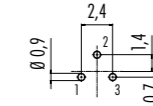
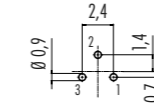

4 pol
4 contacts

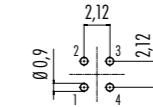
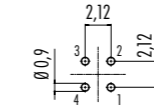

5 pol
5 contacts

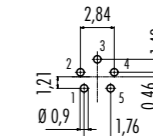
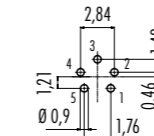

Montageausschnitt
Panel cut out

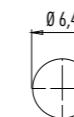

Subminiatur

Subminiature



Snap-in IP67 Subminiatur

Snap-in IP67 Subminiature

Kabelsteckverbinder

- Snap-in-Verriegelung
- 3 – 8-polig
- Schutzart IP67 ¹⁾
- Lötanschluss
- Am Kabel angespritzte Ausführungen
- Durchmesser 11,5 mm
- Farbige Ausführungen

Flanschsteckverbinder

- Snap-in-Verriegelung
- 3 – 8-polig
- Schutzart IP67 ¹⁾
- Löt-/Tauchlötanschluss
- Durchmesser 11,5 mm
- Farbige Ausführungen

Cable Connectors

- Snap-in locking system
- 3 – 8 contacts
- Degree of protection IP67 ¹⁾
- Solder termination
- Moulded versions
- Diameter 11.5 mm
- Coloured versions

Panel Mount Connectors

- Snap-in locking system
- 3 – 8 contacts
- Degree of protection IP67 ¹⁾
- Solder/dip solder termination
- Diameter 11.5 mm
- Coloured versions

¹⁾Erläuterung der Schutzarten siehe technische Informationen./ ¹⁾Explanation of protection standards see technical information.

Kabelstecker
Male cable connector

Kabelstecker, rot, blau, grün
Male cable connector, red, blue, green

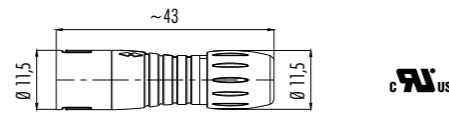

Polzahl Contacts	Kabeldurchlass max. Max. cable outlet	Bestell-Nr. Ordering-No.	Polzahl Contacts	Kabel-Ø max. Max. cable Ø	Rot Red	Blau Blue	Grün Green
3	3,5–5 mm	99 9205 00 03	3	3,5–5 mm	99 9205 050 03	99 9205 060 03	99 9205 070 03
4	3,5–5 mm	99 9209 00 04	4	3,5–5 mm	99 9209 050 04	99 9209 060 04	99 9209 070 04
5	3,5–5 mm	99 9213 00 05	5	3,5–5 mm	99 9213 050 05	99 9213 060 05	99 9213 070 05
8	3,5–5 mm	99 9225 00 08	8	3,5–5 mm	99 9225 050 08	99 9225 060 08	99 9225 070 08

Polzahl	3	4	5	8	Number of contacts
Steckverbinder Verriegelung	schnapp/snap-in				Connector locking system
Anschlussart	löten/solder				Termination
Anschlussquerschnitt	max. 0,25 mm ² (max. AWG 24)				Wire gauge
Kabeldurchlass	3,5–5 mm				Cable outlet
Schutzart	IP67				Degree of protection
Mechanische Lebensdauer	> 500 Steckzyklen/> 500 mating cycles				Mechanical operation
Obere Grenztemperatur	+ 85 °C				Upper temperature
Untere Grenztemperatur	– 25 °C				Lower temperature
Bemessungsspannung	125 V			63 V	Rated voltage
Bemessungs-Stoßspannung	1500 V			800 V	Rated impulse voltage
Verschmutzungsgrad	2				Pollution degree
Überspannungskategorie	II				Overvoltage categorie
Isolierstoffgruppe	II				Material group
Bemessungsstrom (40°C)	3 A	2,5 A	2 A	1 A	Rated current (40 °C)
Material Kontakt	CuZn (Messing/brass)				Material of contact
Kontaktoberfläche	Au (Gold/gold)				Contact plating
Material Kontaktkörper	PA				Material of contact body
Material Gehäuse	PA				Material of housing
Material Verriegelung	—				Material of locking

Kabeldose
Female cable connector

Kabeldose, rot, blau, grün
Female cable connector, red, blue, green

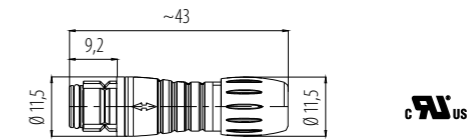

Polzahl Contacts	Kabeldurchlass max. Max. cable outlet	Bestell-Nr. Ordering-No.	Polzahl Contacts	Kabel-Ø max. Max. cable Ø	Rot Red	Blau Blue	Grün Green
3	3,5–5 mm	99 9206 00 03	3	3,5–5 mm	99 9206 050 03	99 9206 060 03	99 9206 070 03
4	3,5–5 mm	99 9210 00 04	4	3,5–5 mm	99 9210 050 04	99 9210 060 04	99 9210 070 04
5	3,5–5 mm	99 9214 00 05	5	3,5–5 mm	99 9214 050 05	99 9214 060 05	99 9214 070 05
8	3,5–5 mm	99 9226 00 08	8	3,5–5 mm	99 9226 050 08	99 9226 060 08	99 9226 070 08

Polzahl	3	4	5	8	Number of contacts
Steckverbinder Verriegelung	schnapp/snap-in				Connector locking system
Anschlussart	löten/solder				Termination
Anschlussquerschnitt	max. 0,25 mm ² (max. AWG 24)				Wire gauge
Kabeldurchlass	3,5–5 mm				Cable outlet
Schutzart	IP67				Degree of protection
Mechanische Lebensdauer	> 500 Steckzyklen/> 500 mating cycles				Mechanical operation
Obere Grenztemperatur	+ 85 °C				Upper temperature
Untere Grenztemperatur	– 25 °C				Lower temperature
Bemessungsspannung	125 V			63 V	Rated voltage
Bemessungs-Stoßspannung	1500 V			800 V	Rated impulse voltage
Verschmutzungsgrad	2				Pollution degree
Überspannungskategorie	II				Overvoltage categorie
Isolierstoffgruppe	II				Material group
Bemessungsstrom (40°C)	3 A	2,5 A	2 A	1 A	Rated current (40 °C)
Material Kontakt	CuSn (Bronze/bronze)				Material of contact
Kontaktoberfläche	Au (Gold/gold)				Contact plating
Material Kontaktkörper	PA				Material of contact body
Material Gehäuse	PA				Material of housing
Material Verriegelung	—				Material of locking

Flanschstecker Male panel mount connector
 Flanschstecker, rot Male panel mount connector, red
 Flanschstecker, blau Male panel mount connector, blue
 Flanschstecker, grün Male panel mount connector, green
 Flanschstecker, tauchlöten Male panel mount connector, dip solder



Bohrbilder siehe Seite 20
Drilling schemes see page 20

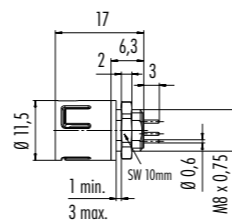
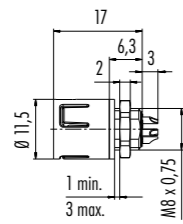

Polzahl Contacts	Bestell-Nr. Ordering-No.	Polzahl Contacts	Bestell-Nr. Ordering-No.	Polzahl Contacts	Bestell-Nr. Ordering-No.	Polzahl Contacts	Bestell-Nr. Ordering-No.	Polzahl Contacts	Bestell-Nr. Ordering-No.
3	99 9207 00 03	3	99 9207 050 03	3	99 9207 060 03	3	99 9207 070 03	3	99 9207 090 03
4	99 9211 00 04	4	99 9211 050 03	4	99 9211 060 04	4	99 9211 070 04	4	99 9211 090 04
5	99 9215 00 05	5	99 9215 050 05	5	99 9215 060 05	5	99 9215 070 05	5	99 9215 090 05
8	99 9227 00 08	8	99 9227 050 08	8	99 9227 060 08	8	99 9227 070 08	8	99 9227 090 08

Polzahl	3	4	5	8	Number of contacts
Steckverbinder Verriegelung	schnapp/snap-in				Connector locking system
Anschlussart	löten/tauchlöten/solder/dip solder				Termination
Anschlussquerschnitt	max. 0,25 mm ² (max. AWG 24)/ —				Wire gauge
Kabeldurchlass	—				Cable outlet
Schutzart	IP67				Degree of protection
Mechanische Lebensdauer	> 500 Steckzyklen/> 500 mating cycles				Mechanical operation
Obere Grenztemperatur	+ 85 °C				Upper temperature
Untere Grenztemperatur	- 25 °C				Lower temperature
Bemessungsspannung	125 V			63 V	Rated voltage
Bemessungs-Stoßspannung	1500 V			800 V	Rated impulse voltage
Verschmutzungsgrad	2				Pollution degree
Überspannungskategorie	II				Overvoltage categorie
Isolierstoffgruppe	II				Material group
Bemessungsstrom (40°C)	3 A	2,5 A	2 A	1 A	Rated current (40 °C)
Material Kontakt	CuZn (Messing/brass)				Material of contact
Kontaktoberfläche	Au (Gold/gold)				Contact plating
Material Kontaktkörper	PA				Material of contact body
Material Gehäuse	PA				Material of housing
Material Verriegelung	—				Material of locking

Flanschdose Female panel mount connector
 Flanschdose, rot Female panel mount connector, red
 Flanschdose, blau Female panel mount connector, blue
 Flanschdose, grün Female panel mount connector, green
 Flanschdose, tauchlöten Female panel mount connector, dip solder



Bohrbilder siehe Seite 20
Drilling schemes see page 20

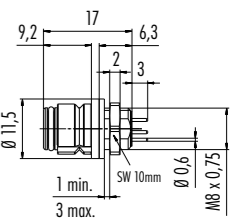
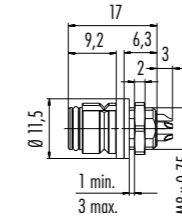

Polzahl Contacts	Bestell-Nr. Ordering-No.	Polzahl Contacts	Bestell-Nr. Ordering-No.	Polzahl Contacts	Bestell-Nr. Ordering-No.	Polzahl Contacts	Bestell-Nr. Ordering-No.	Polzahl Contacts	Bestell-Nr. Ordering-No.
3	99 9208 00 03	3	99 9208 050 03	3	99 9208 060 03	3	99 9208 070 03	3	99 9208 090 03
4	99 9212 00 04	4	99 9212 050 04	4	99 9212 060 04	4	99 9212 070 04	4	99 9212 090 04
5	99 9216 00 05	5	99 9216 050 05	5	99 9216 060 05	5	99 9216 070 05	5	99 9216 090 05
8	99 9228 00 08	8	99 9228 050 08	8	99 9228 060 08	8	99 9228 070 08	8	99 9228 090 08

Polzahl	3	4	5	8	Number of contacts
Steckverbinder Verriegelung	schnapp/snap-in				Connector locking system
Anschlussart	löten/tauchlöten/solder/dip solder				Termination
Anschlussquerschnitt	max. 0,25 mm ² (max. AWG 24)/ —				Wire gauge
Kabeldurchlass	—				Cable outlet
Schutzart	IP67				Degree of protection
Mechanische Lebensdauer	> 500 Steckzyklen/> 500 mating cycles				Mechanical operation
Obere Grenztemperatur	+ 85 °C				Upper temperature
Untere Grenztemperatur	- 25 °C				Lower temperature
Bemessungsspannung	125 V			63 V	Rated voltage
Bemessungs-Stoßspannung	1500 V			800 V	Rated impulse voltage
Verschmutzungsgrad	2				Pollution degree
Überspannungskategorie	II				Overvoltage categorie
Isolierstoffgruppe	II				Material group
Bemessungsstrom (40°C)	3 A	2,5 A	2 A	1 A	Rated current (40 °C)
Material Kontakt	CuSn (Bronze/bronze)				Material of contact
Kontaktoberfläche	Au (Gold/gold)				Contact plating
Material Kontaktkörper	PA				Material of contact body
Material Gehäuse	PA				Material of housing
Material Verriegelung	—				Material of locking

Kabelstecker umspritzt
Male cable connector moulded



Kabeldose umspritzt
Female cable connector moulded

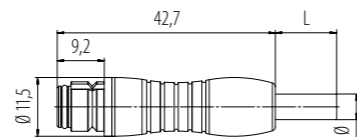
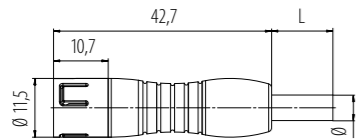

Polzahl Contacts	Kabellänge Cable length	Bestell-Nr. Ordering-No.	Polzahl Contacts	Kabellänge Cable length	Bestell-Nr. Ordering-No.
3	2 m	77 7405 0000 50003 - 0200	3	2 m	77 7406 0000 50003 - 0200
4	2 m	77 7405 0000 50004 - 0200	4	2 m	77 7406 0000 50004 - 0200
5	2 m	77 7405 0000 50005 - 0200	5	2 m	77 7406 0000 50005 - 0200
8	2 m	77 7405 0000 50008 - 0200	8	2 m	77 7406 0000 50008 - 0200

Technische Daten Kabel	3	4	5	8	Specifications of cable
Querschnitt mm ² ¹⁾	3 x 0,25 mm ² (AWG 24)	4 x 0,25 mm ² (AWG 24)	5 x 0,25 mm ² (AWG 24)	8 x 0,25 mm ² (AWG 24)	Wire gauge mm ² ¹⁾
Material Mantel	PUR				Material jacket
Isolation Litze	PP		PVC	PP	Insulation wire
Litzenaufbau (mm)	32 x 0,1				Design of wire (mm)
Kabelmantel Ø (mm)	3,6 ±0,1	4,5 ±0,1	4,95 ±0,15	6 ±0,2	Cable jacket Ø (mm)
Leiterwiderstand	80 Ω/Km (20 °C)		78 Ω/Km (20 °C)	79 Ω/Km (20 °C)	Resistance of wire
Temp.-Bereich (Kabel bew.)	- 25 °C /+ 80 °C	- 25 °C /+ 90 °C	- 15 °C /+ 80 °C	- 25 °C /+ 80 °C	Temp. range (cable in move)
Temp.-Bereich (Kabel fest)	- 40 °C /+ 80 °C	- 40 °C /+ 90 °C	- 30 °C /+ 80 °C	- 50 °C /+ 80 °C	Temp. range (cable fixed)
Biegeradius (Kabel bew.)	36 mm	45 mm	49,5 mm	60 mm	Bending radius (cable in move)
Biegeradius (Kabel fest)	18 mm	22,5 mm	24,75 mm	30 mm	Bending radius (cable fixed)
Zulassung	UL				Approval

Polzahl	3	4	5	8	Number of contacts
Steckverbinder Verriegelung	schnapp/snap-in				Connector locking system
Anschlussart	am Kabel angespritzt/moulded				Termination
Anschlussquerschnitt	max. 0,25 mm ² (max. AWG 24)				Wire gauge
Kabeldurchlass	—				Cable outlet
Schutzart	IP67				Degree of protection
Mechanische Lebensdauer	> 500 Steckzyklen/> 500 mating cycles				Mechanical operation
Obere Grenztemperatur	+ 70 °C				Upper temperature
Untere Grenztemperatur	- 25 °C				Lower temperature
Bemessungsspannung	125 V			63 V	Rated voltage
Bemessungs-Stoßspannung	1500 V			800 V	Rated impulse voltage
Verschmutzungsgrad	2				Pollution degree
Überspannungskategorie	II				Overvoltage categorie
Isolierstoffgruppe	II				Material group
Bemessungsstrom (40°C)	3 A	2,5 A	2 A	1 A	Rated current (40 °C)
Material Kontakt	Stift/pin CuZn (Messing/brass), Buchse/socket CuSn (Bronze/bronze)				Material of contact
Kontaktoberfläche	Au (Gold/gold)				Contact plating
Material Kontaktkörper	PA				Material of contact body
Material Gehäuse	PUR				Material of housing
Material Verriegelung	—				Material of locking

¹⁾ Vergleichbare AWG Leiter siehe technische Informationen./ ¹⁾ Comparable AWG conductors see technical information.

Montageanleitung
Assembly instruction

1. Abmanteln auf L = 12 mm.
2. Druckschraube, Klemmkorb, Dichtring und Kupplungshülse auf Kabel auffädeln.
3. O-Ring auf Kontakteinsatz aufziehen.
4. Litzen abisolieren und anlöten.
5. Kupplungshülse aufschrauben.
6. Druckschraube festdrehen.

1. Dismantle cable to 12 mm length.
2. Bead pressing screw, pinch ring, seal and sleeve to cable.
3. Fit O-ring on the contact insert.
4. Strip and solder single wires.
5. Screw on sleeve.
6. Tighten pressing screw.

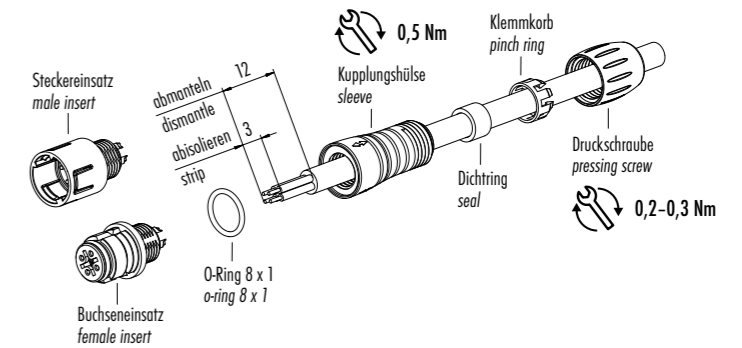

Einzelteildarstellung
Component part drawing

Flanschsteckverbinder, löten
Panel mount connectors, solder

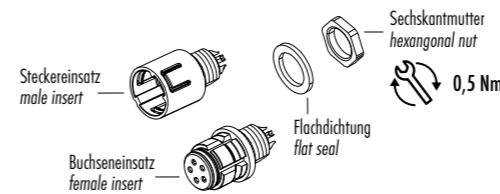

Flanschsteckverbinder, tauchlöten
Panel mount connectors, dip solder

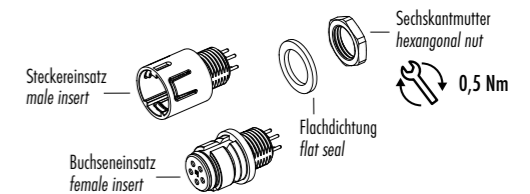

Montage Adapter
Assembly of adapter

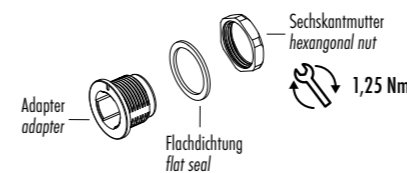

Montage Adapter, von vorn verschraubbar
Assembly of adapter, front fastened

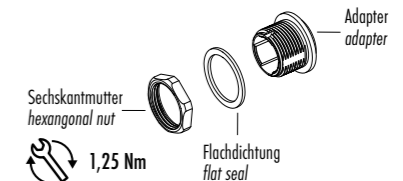

Adapter
Adapter

Die Markierung des Adapters muss mit der Kodiumse des Einsatzes übereinstimmen
The marking of the adapter must conform with the coding nut of the insert

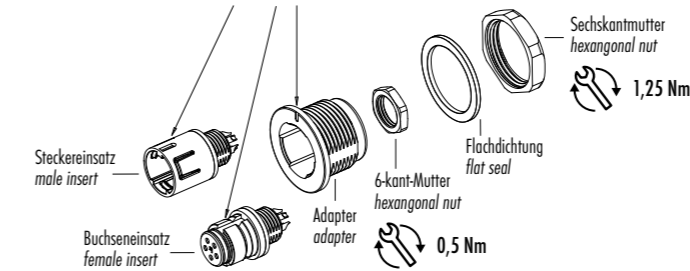

Einsätze müssen separat bestellt werden
Inserts have to be ordered separately

Adapter, von vorn verschraubbar
Adapter, front fastened

Die Markierung des Adapters muss mit der Kodiumse des Einsatzes übereinstimmen
The marking of the adapter must conform with the coding nut of the insert

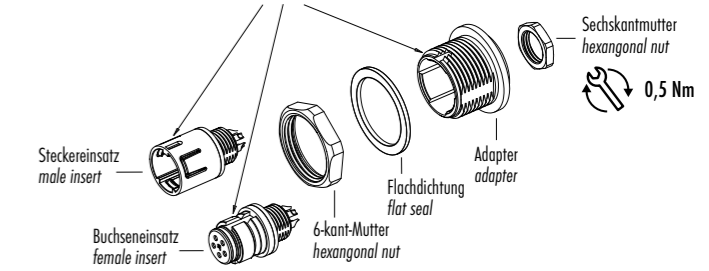

Einsätze müssen separat bestellt werden
Inserts have to be ordered separately

Polbilder
Contact arrangements

Stifteinsatz (Steckseite)
Male insert (mating side)

Buchseinsatz (Steckseite)
Female insert (mating side)

3 pol
3 contacts

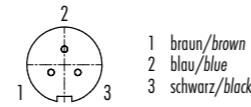
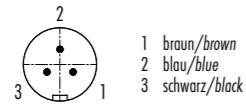

4 pol
4 contacts

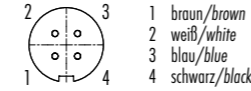
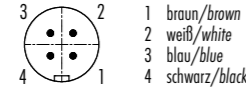

5 pol
5 contacts

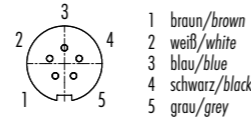
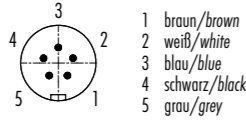

8 pol
8 contacts

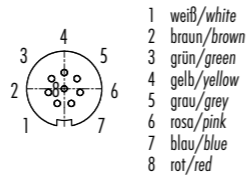
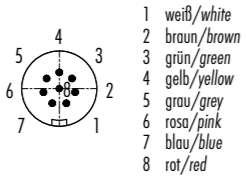

Bohrbilder Stifteinsatz (Leiterplatte)
Drilling schemes male insert (PCB)

Bohrbilder Buchseinsatz (Leiterplatte)
Drilling schemes female insert (PCB)

3 pol
3 contacts

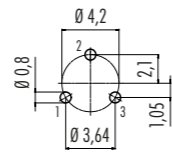
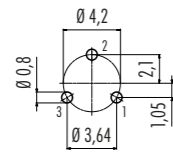

4 pol
4 contacts

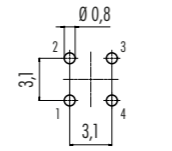
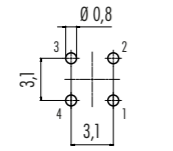

5 pol
5 contacts

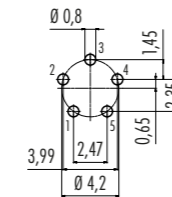
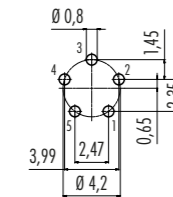

8 pol
8 contacts

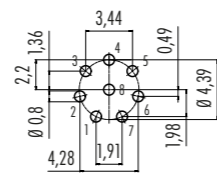
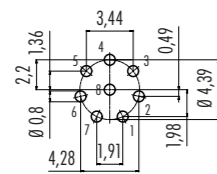

Montageausschnitt
Panel cut out

Flanschsteckverbinder
Socket connectors

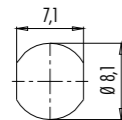

Adapter
Adapter

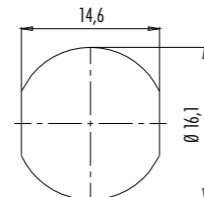

Bezeichnung / Description

Maßzeichnung / Drawing

Bestell-Nr. / Ordering-No.

Schutzkappe für
Kabelstecker
Protection cap
for male cable
connector

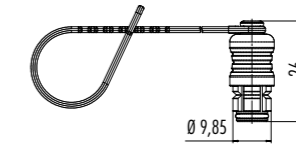

08 2813 000 000

Schutzkappe für
Kabeldose
Protection cap
for female cable
connector

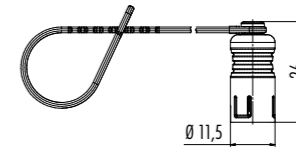

08 2823 000 000

Schutzkappe für
Flanschstecker
Protection cap for
male panel mount
connector

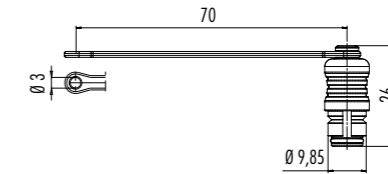

08 2839 000 000

Schutzkappe für
Flanschdose
Protection cap for
female panel mount
connector

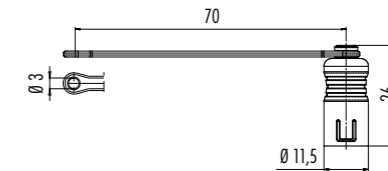

08 2831 000 000

Adapter für Flansch-
steckverbinder
Adapter for panel
mount connectors

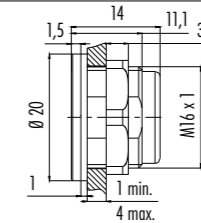

08 2636 000 001

Adapter für Flansch-
steckverbinder,
von vorn verschraubt
Adapter for panel
mount connectors,
front fastened

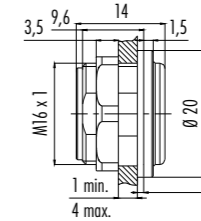

08 2629 000 001

Sicherungsclip
Safety clip

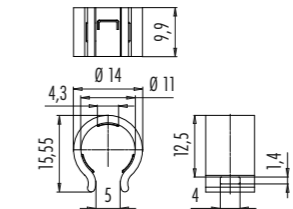

08 0219 000 000

Anwendungsbeispiel für Adapter
Example for use for adapter

Flanschstecker
Male panel mount connector



Flanschstecker mit Adapter
Male panel mount connector
with adapter



Flanschdose
Female panel mount connector



Flanschdose mit Adapter, von
vorn verschraubbar
Female panel mount connector
with adapter, front fastened



Subminiatur

Subminiature



Bajonett NCC Subminiatur

Bayonet NCC Subminiature

Kabelsteckverbinder

- Bajonett-Verriegelung
- 5-polig
- Schutzart IP67¹⁾
- Lötanschluss
- Durchmesser 16 mm

Cable Connectors

- Bayonet locking system
- 5 contacts
- Degree of protection IP67¹⁾
- Solder termination
- Diameter 16 mm

Flanschsteckverbinder

- Bajonett-Verriegelung
- 5-polig
- Schutzart IP54¹⁾ in ungestecktem Zustand
- Löt-/Tauchlötanschluss
- > 1000 Steckzyklen

Panel Mount Connectors

- Bayonet locking system
- 5 contacts
- Degree of protection IP54¹⁾ when not connected
- Solder/dip solder termination
- > 1000 mating cycles

¹⁾Erläuterung der Schutzarten siehe technische Informationen./ ¹⁾Explanation of protection standards see technical information.

Kabelstecker
Male cable connector



Flanschdose, löten
Female panel mount connector, solder



Flanschdose, löten, von vorn verschraubbar
Female panel mount connector, solder, front fastened

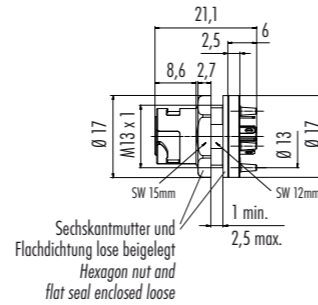
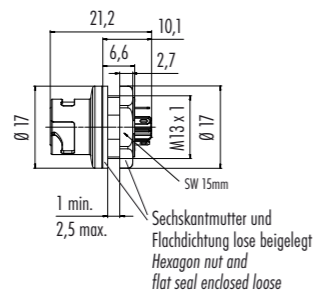
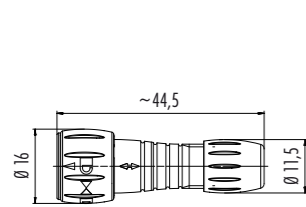

Polzahl Contacts	Kabeldurchlass max. Max. cable outlet	Bestell-Nr. Ordering-No.	Polzahl Contacts	Bestell-Nr. Ordering-No.	Polzahl Contacts	Bestell-Nr. Ordering-No.
5	3–5 mm	99 0759 010 05	5	09 0762 000 05	5	09 0762 180 05

Polzahl	5	Number of contacts
Steckverbinder Verriegelung	Bajonett/bayonet	Connector locking system
Anschlussart	löten/solder	Termination
Anschlussquerschnitt	0,25 mm ² (AWG 24)	Wire gauge
Kabeldurchlass	3,5–5 mm/—	Cable outlet
Schutzart	Kabelstecker IP67/male cable connector IP67, Flanschteile IP54 ungesteckt, IP67 gesteckt/panel mount parts IP54 when not mated, IP67 when mated	Degree of protection
Mechanische Lebensdauer	> 1000 Steckzyklen/> 1000 mating cycles	Mechanical operation
Obere Grenztemperatur	+ 85 °C	Upper temperature
Untere Grenztemperatur	– 25 °C	Lower temperature
Bemessungsspannung	50 V	Rated voltage
Bemessungs-Stoßspannung	500 V	Rated impulse voltage
Verschmutzungsgrad	2	Pollution degree
Überspannungskategorie	II	Overvoltage categorie
Isolierstoffgruppe	II	Material group
Bemessungsstrom (40°C)	2 A	Rated current (40 °C)
Material Kontakt	Stift/pin CuZn (Messing/brass), Buchse/socket CuSn (Bronze/bronze)	Material of contact
Kontaktoberfläche	Au (Gold/gold)	Contact plating
Material Kontaktkörper	PA	Material of contact body
Material Gehäuse	PA	Material of housing
Material Verriegelung	PA/—	Material of locking

Flanschdose, tauchlöten
Female panel mount connector, dip solder



Flanschdose, tauchlöten, von vorn verschraubbar
Female panel mount connector, dip solder, front fastened



Bohrbild siehe Seite 26
Drilling scheme see page 26

Bohrbild siehe Seite 26
Drilling scheme see page 26

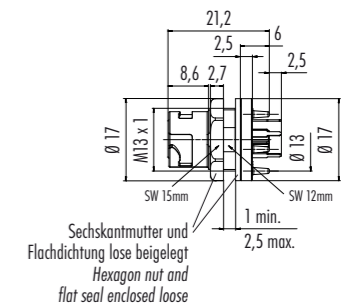
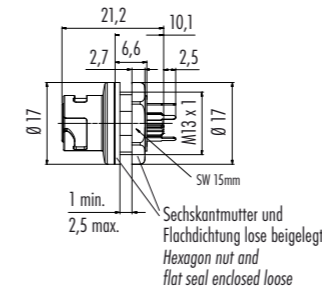

Polzahl Contacts	Bestell-Nr. Ordering-No.	Polzahl Contacts	Bestell-Nr. Ordering-No.
5	09 0762 090 05	5	09 0762 190 05

Polzahl	5	Number of contacts
Steckverbinder Verriegelung	Bajonett/bayonet	Connector locking system
Anschlussart	Stift/pin CuZn (Messing/brass), Buchse/socket CuSn (Bronze/bronze)	Termination
Anschlussquerschnitt	—	Wire gauge
Kabeldurchlass	—	Cable outlet
Schutzart	IP54 ungesteckt, IP67 gesteckt/IP54 when not mated, IP67 when mated	Degree of protection
Mechanische Lebensdauer	> 1000 Steckzyklen/> 1000 mating cycles	Mechanical operation
Obere Grenztemperatur	+ 85 °C	Upper temperature
Untere Grenztemperatur	– 25 °C	Lower temperature
Bemessungsspannung	50 V	Rated voltage
Bemessungs-Stoßspannung	500 V	Rated impulse voltage
Verschmutzungsgrad	2	Pollution degree
Überspannungskategorie	II	Overvoltage categorie
Isolierstoffgruppe	II	Material group
Bemessungsstrom (40°C)	2 A	Rated current (40 °C)
Material Kontakt	CuSn (Bronze/bronze)	Material of contact
Kontaktoberfläche	Au (Gold/gold)	Contact plating
Material Kontaktkörper	PA	Material of contact body
Material Gehäuse	PA	Material of housing
Material Verriegelung	—	Material of locking

Montageanleitung
Assembly instruction

Kabelstecker
Male cable connector

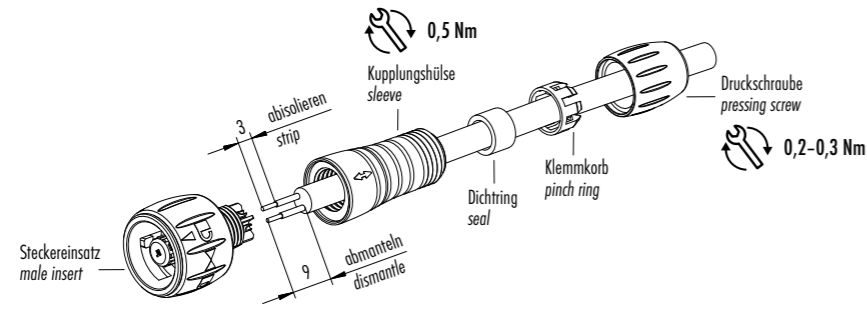

Einzelteildarstellung
Component part drawing

Flanschdose, löten
Female panel mount connector, solder

Flanschdose, löten, von vorn verschraubbar
Female panel mount connector, solder, front fastened

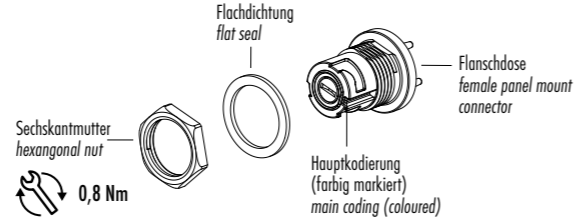
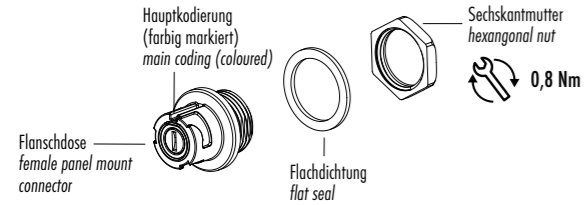

Flanschdose, tauchlöten
Female panel mount connector, dip solder

Flanschdose, tauchlöten, von vorn verschraubbar
Female panel mount connector, dip solder, front fastened

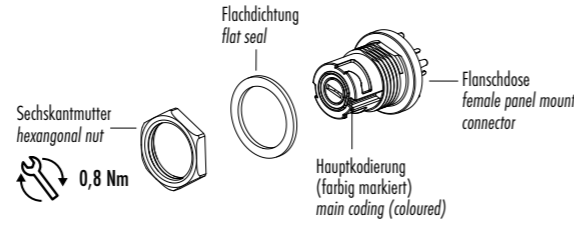
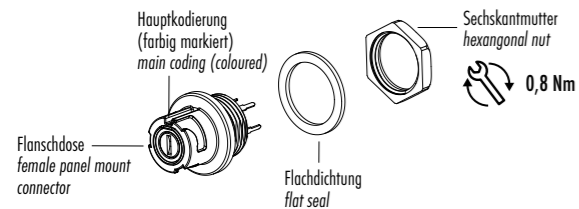

Polbilder
Contact arrangements

Stifteinsatz (Anschlussseite)
Male insert (termination side)

Buchseinsatz (Anschlussseite)
Female insert (termination side)

5 pol
5 contacts

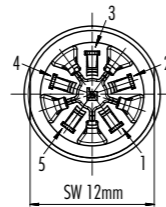

Bohrbild Stifteinsatz (Leiterplatte)
Drilling scheme male insert (PCB)

Bohrbild Buchseinsatz (Leiterplatte)
Drilling scheme female insert (PCB)

5 pol
5 contacts

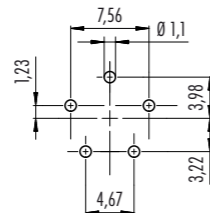

Montageausschnitt
Panel cut out

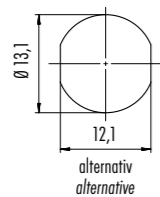

Bezeichnung / Description

Maßzeichnung / Drawing

Bestell-Nr. / Ordering-No.

Schutzkappe für Kabelstecker
Protection cap for male cable connector

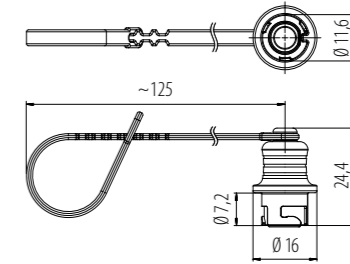

08 0375 000 000

Subminiatur

Subminiature



Bajonett Subminiatur

Bayonet Subminiature

Kabelsteckverbinder

- Bajonett-Verriegelung
- 2 – 8-polig
- Schutzart IP40 ¹⁾
- Lötanschluss
- Durchmesser 12 mm

Flanschsteckverbinder

- Bajonett-Verriegelung
- 2 – 8-polig
- Schutzart IP40 ¹⁾
- Lötanschluss
- Durchmesser 12 mm

Cable Connectors

- Bayonet locking system
- 2 – 8 contacts
- Degree of protection IP40 ¹⁾
- Solder termination
- Diameter 12 mm

Panel Mount Connectors

- Bayonet locking system
- 2 – 8 contacts
- Degree of protection IP40 ¹⁾
- Solder termination
- Diameter 12 mm

¹⁾Erläuterung der Schutzarten siehe technische Informationen./ ¹⁾Explanation of protection standards see technical information.

Kabelstecker
Male cable connector

Kabeldose
Female cable connector

Flanschstecker
Male panel mount connector

Flanschdose
Female panel mount connector

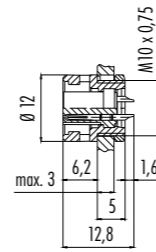
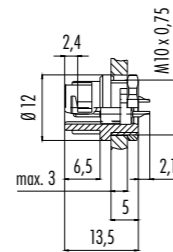
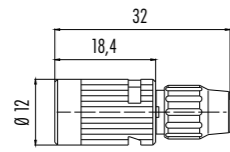
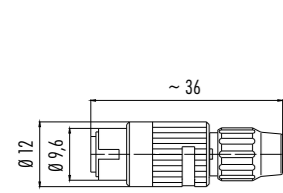

Polzahl Contacts	Kabel-Ø 3–4 mm Cable Ø 3–4 mm	Kabel-Ø 4–5 mm Cable Ø 4–5 mm	Polzahl Contacts	Kabel-Ø 3–4 mm Cable Ø 3–4 mm	Kabel-Ø 4–5 mm Cable Ø 4–5 mm	Polzahl Contacts	Bestell-Nr. Ordering-No.	Polzahl Contacts	Bestell-Nr. Ordering-No.
2	99 0971 100 02	99 0971 102 02	2	99 0972 100 02	99 0972 102 02	2	09 0973 00 02	2	09 0974 00 02
3	99 0975 100 03	99 0975 102 03	3	99 0976 100 03	99 0976 102 03	3	09 0977 00 03	3	09 0978 00 03
4	99 0979 100 04	99 0979 102 04	4	99 0980 100 04	99 0980 102 04	4	09 0981 00 04	4	09 0982 00 04
5	99 0995 100 05	99 0995 102 05	5	99 0996 100 05	99 0996 102 05	5	09 0997 00 05	5	09 0998 00 05
7	99 9475 100 07	99 9475 102 07	7	99 9476 100 07	99 9476 102 07	7	09 9477 00 07	7	09 9478 00 07
8	99 9479 100 08	99 9479 102 08	8	99 9480 100 08	99 9480 102 08	8	09 9481 00 08	8	09 9482 00 08

Polzahl	2	3	4	5	7	8	Number of contacts
Steckverbinder Verriegelung	Bajonett/bayonet						Connector locking system
Anschlussart	löten/solder						Termination
Anschlussquerschnitt	max. 0,25 mm ² (max. AWG 24)			max. 0,14 mm ² (max. AWG 26)			Wire gauge
Kabeldurchlass	3–4 mm, 4–5 mm/ —						Cable outlet
Schutzart	IP40						Degree of protection
Mechanische Lebensdauer	> 500 Steckzyklen/> 500 mating cycles						Mechanical operation
Obere Grenztemperatur	+ 85 °C						Upper temperature
Untere Grenztemperatur	– 40 °C						Lower temperature
Bemessungsspannung	125 V						Rated voltage
Bemessungs-Stoßspannung	1500 V						Rated impulse voltage
Verschmutzungsgrad	1						Pollution degree
Überspannungskategorie	II						Overvoltage categorie
Isolierstoffgruppe	III						Material group
Bemessungsstrom (40 °C)	4 A		3 A		1 A		Rated current (40 °C)
Material Kontakt	Stift/pin CuZn (Messing/brass), Buchse/socket CuSn (Bronze/bronze)						Material of contact
Kontaktoberfläche	Au (Gold/gold)						Contact plating
Material Kontaktkörper	PA						Material of contact body
Material Gehäuse	PA						Material of housing
Material Verriegelung	PA/ —						Material of locking

Montageanleitung
Assembly instruction

Kabelstecker
Male cable connector

1. Druckschraube auf Kabel auffädeln.
2. Kabel abmanteln auf L = 15 mm.
3. Litzen abisolieren und anlöten.
4. Steckereinsatz in Hülse montieren.
5. Hülse mit Steckereinsatz in Trägerhalbschale Unterteil setzen.
6. Trägerhalbschale Oberteil auf Unterteil montieren.
7. Trägerbaugruppe in Gewinding schnappen.
8. Druckschraube festziehen.

1. Bead pressing screw to cable.
2. Dismantle cable to 15 mm length.
3. Strip and solder single wires.
4. Mount male insert into sleeve.
5. Insert sleeve with male insert into carrier sleeve part 2 (lower part grey).
5. Mount carrier sleeve part 1 (upper part black) on carrier sleeve part 2 (lower part grey).
6. Snap assembly group into coupling ring.
7. Tighten pressing screw.

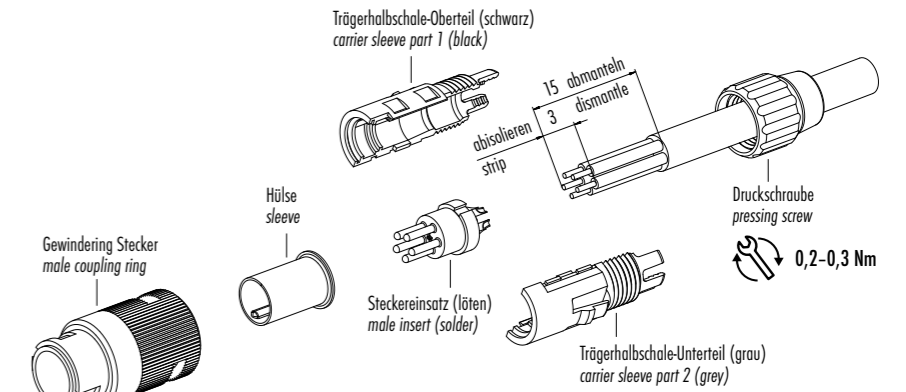

Kabeldose
Female cable connector

1. Druckschraube auf Kabel auffädeln.
2. Kabel abmanteln auf L = 15 mm.
3. Litzen abisolieren und anlöten.
4. Buchseneinsatz in Trägerhalbschale Unterteil legen.
5. Trägerhalbschale Oberteil auf Unterteil montieren.
6. Trägerbaugruppe in Gewinding schnappen.
7. Druckschraube festziehen.

1. Bead pressing screw to cable.
2. Dismantle cable to 15 mm length.
3. Strip and solder single wires.
4. Place female insert into carrier sleeve part 2 (lower part grey).
4. Mount carrier sleeve part 1 (upper part black) on carrier sleeve part 2 (lower part grey).
5. Snap assembly group into coupling ring.
6. Tighten pressing screw.

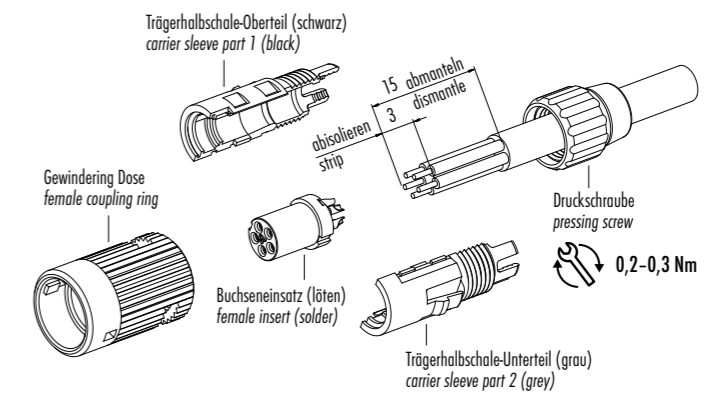

Einzelteildarstellung
Component part drawing

Flanschsteckverbinder
Panel mount connectors

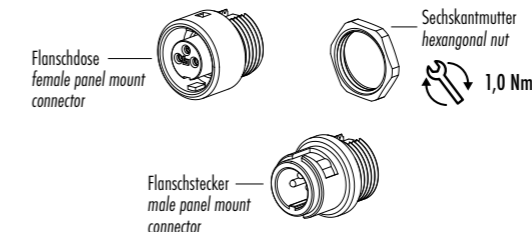

Polbilder
Contact arrangements

Stifteinsatz (Steckseite)
Male insert (mating side)

Buchseinsatz (Steckseite)
Female insert (mating side)

2 pol
2 contacts

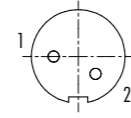
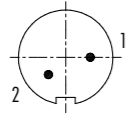

3 pol
3 contacts

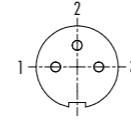
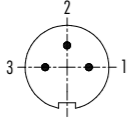

4 pol
4 contacts

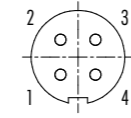
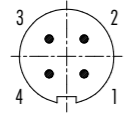

5 pol
5 contacts

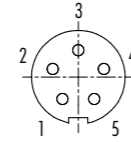
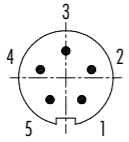

7 pol
7 contacts

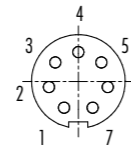
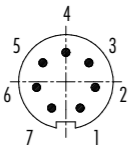

8 pol
8 contacts

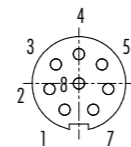
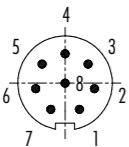

Montageausschnitt
Panel cut out

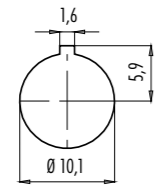

Subminiatur

Subminiature



Push-Pull Subminiatur

Push-Pull Subminiature

Kabelsteckverbinder

- Push-Pull-Verriegelung
- 3 – 8-polig
- Schutzart IP40/IP67 ¹⁾
- Lötanschluss
- Durchmesser 14,5 mm
- Schirmbar

Flanschsteckverbinder

- Push-Pull-Verriegelung
- 3 – 8 polig
- Schutzart IP40/IP67 ¹⁾
- Lötanschluss
- Durchmesser 17,5 mm
- Schirmbare Ausführungen

Cable Connectors

- Push-pull locking system
- 3 – 8 contacts
- Degree of protection IP40/IP67 ¹⁾
- Solder termination
- Diameter 14.5 mm
- Shieldable

Panel Mount Connectors

- Push-pull locking system
- 3–8 contacts
- Degree of protection IP40/IP67 ¹⁾
- Solder termination
- Diameter 17.5 mm
- Shieldable versions

¹⁾Erläuterung der Schutzarten siehe technische Informationen./ ¹⁾Explanation of protection standards see technical information.

Kabelstecker, schirmbar, IP67
Male cable connector, shieldable, IP67

Kabeldose, schirmbar, IP67
Female cable connector, shieldable, IP67

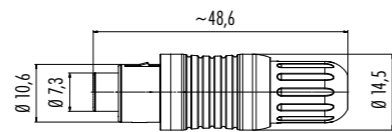
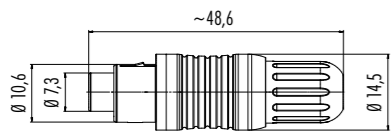

Polzahl Contacts	Kabeldurchlass Cable outlet	Bestell-Nr. Ordering-No.	Polzahl Contacts	Kabeldurchlass Cable outlet	Bestell-Nr. Ordering-No.
3	3,5–5 mm	99 4905 00 03	3	3,5–5 mm	99 4906 00 03
4	3,5–5 mm	99 4909 00 04	4	3,5–5 mm	99 4910 00 04
5	3,5–5 mm	99 4913 00 05	5	3,5–5 mm	99 4914 00 05
7	3,5–5 mm	99 4925 00 07	7	3,5–5 mm	99 4926 00 07
8	3,5–5 mm	99 4929 00 08	8	3,5–5 mm	99 4930 00 08

Polzahl	3	4	5	7	8	Number of contacts
Steckverbinder Verriegelung	Push-Pull					Connector locking system
Anschlussart	löten/solder					Termination
Anschlussquerschnitt	0,25 mm ² (AWG 24)		0,14 mm ² (AWG 26)			Wire gauge
Kabeldurchlass	3,5–5 mm					Cable outlet
Schutzart	IP67					Degree of protection
Mechanische Lebensdauer	> 500 Steckzyklen/> 500 mating cycles					Mechanical operation
Obere Grenztemperatur	+ 85 °C					Upper temperature
Untere Grenztemperatur	– 25 °C					Lower temperature
Bemessungsspannung	125 V					Rated voltage
Bemessungs-Stoßspannung	1500 V					Rated impulse voltage
Verschmutzungsgrad	1					Pollution degree
Überspannungskategorie	II					Overvoltage categorie
Isolierstoffgruppe	III					Material group
Bemessungsstrom (40 °C)	4 A	3 A		1 A		Rated current (40 °C)
Material Kontakt	Stift/pin CuZn (Messing/brass), Buchse/socket CuSn (Bronze/bronze)					Material of contact
Kontaktfläche	Au (Gold/gold)					Contact plating
Material Kontaktkörper	PBT/PA					Material of contact body
Material Gehäuse	PA					Material of housing
Material Verriegelung	PA					Material of locking

Flanschstecker
Male panel mount connector

Flanschstecker, von vorn verschraubbar
Male panel mount connector, front fastened

Flanschdose
Female panel mount connector

Flanschdose, von vorn verschraubbar
Female panel mount connector, front fastened

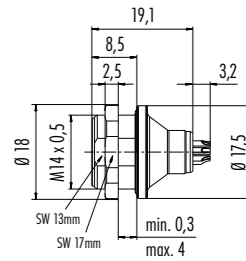
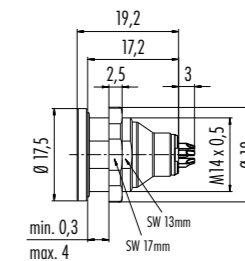
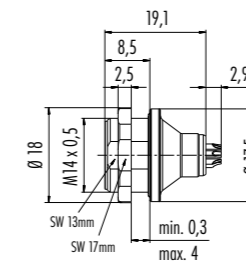
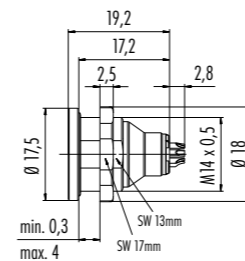

Schutzart Protection	Polzahl Contacts	Bestell-Nr. Ordering-No.	Schutzart Protection	Polzahl Contacts	Bestell-Nr. Ordering-No.	Schutzart Protection	Polzahl Contacts	Bestell-Nr. Ordering-No.	Schutzart Protection	Polzahl Contacts	Bestell-Nr. Ordering-No.
IP40	3	09 4907 025 03	IP40	3	—	IP40	3	09 4908 025 03	IP40	3	—
	4	09 4911 025 04		4	—		4	09 4912 025 04		4	—
	5	—		5	—		5	09 4916 025 05		5	—
	7	09 4927 025 07		7	—		7	—		7	—
	8	09 4931 025 08		8	—		8	09 4932 025 08		8	—
IP67	3	09 4907 015 03	IP67	3	09 4907 080 03	IP67	3	09 4908 015 03	IP67	3	09 4908 080 03
	4	09 4911 015 04		4	—		4	09 4912 015 04		4	09 4912 080 04
	5	09 4915 015 05		5	09 4915 080 05		5	09 4916 015 05		5	09 4916 080 05
	7	09 4927 015 07		7	09 4927 080 07		7	09 4928 015 07		7	09 4928 080 07
	8	09 4931 015 08		8	09 4931 080 08		8	09 4932 015 08		8	09 4932 080 08
IP67 geschirmt/ shielded	3	09 4907 00 03	IP67 geschirmt/ shielded	3	09 4907 081 03	IP67 geschirmt/ shielded	3	09 4908 00 03	IP67 geschirmt/ shielded	3	09 4908 081 03
	4	09 4911 00 04		4	09 4911 081 04		4	09 4912 00 04		4	09 4912 081 04
	5	09 4915 00 05		5	09 4915 081 05		5	09 4916 00 05		5	09 4916 081 05
	7	—		7	09 4927 081 07		7	09 4928 00 07		7	09 4928 081 07
	8	09 4931 00 08		8	09 4931 081 08		8	09 4932 00 08		8	09 4932 081 08

Polzahl	3	4	5	7	8	Number of contacts
Steckverbinder Verriegelung	Push-Pull					Connector locking system
Anschlussart	löten/solder					Termination
Anschlussquerschnitt	0,25 mm ² (AWG 24)		0,14 mm ² (AWG 26)			Wire gauge
Kabeldurchlass	—					Cable outlet
Schutzart	IP40/IP67					Degree of protection
Mechanische Lebensdauer	> 500 Steckzyklen/> 500 mating cycles					Mechanical operation
Obere Grenztemperatur	+ 85 °C					Upper temperature
Untere Grenztemperatur	– 25 °C					Lower temperature
Bemessungsspannung	125 V					Rated voltage
Bemessungs-Stoßspannung	1500 V					Rated impulse voltage
Verschmutzungsgrad	1					Pollution degree
Überspannungskategorie	II					Overvoltage categorie
Isolierstoffgruppe	III					Material group
Bemessungsstrom (40 °C)	4 A	3 A		1 A		Rated current (40 °C)
Material Kontakt	Stift/pin CuZn (Messing/brass), Buchse/socket CuSn (Bronze/bronze)					Material of contact
Kontaktfläche	Au (Gold/gold)					Contact plating
Material Kontaktkörper	PBT					Material of contact body
Material Gehäuse	CuZn (Messing vernickelt/brass nickel plated)					Material of housing
Material Verriegelung	—					Material of locking

Montageanleitung
Assembly instruction

1. Abmanteln auf L = 26mm. Ummantelung nicht abstreifen.
2. Druckschraube und Dichtung auf Kabel auffädeln. Dichtung in Klemmvorrichtung montieren. Ummantelung entfernen.
3. Abschirmung auffächern und auskämmen.
4. Litzen abisolieren und verzinnen.
5. Abstandshülse und Klemmvorrichtung verasten.
6. Einsätze anlöten.
7. Abstandshülsen auf Hülse stecken.
8. Klemmvorrichtung verschieben und einrasten. Die Abschirmlitzen in der Krone rundherum einfädeln.
9. Abschirmlitzen in Richtung Abschirmring abstreifen und kürzen.
zu lang: Litzen auf Dichtring - undicht
zu kurz: kein Kontakt zu Wellenring
10. Montierte Einheit in Trägerhülse stecken. Dabei Position der Kodiernose beachten.
11. Druckschraube aufstecken und festziehen.

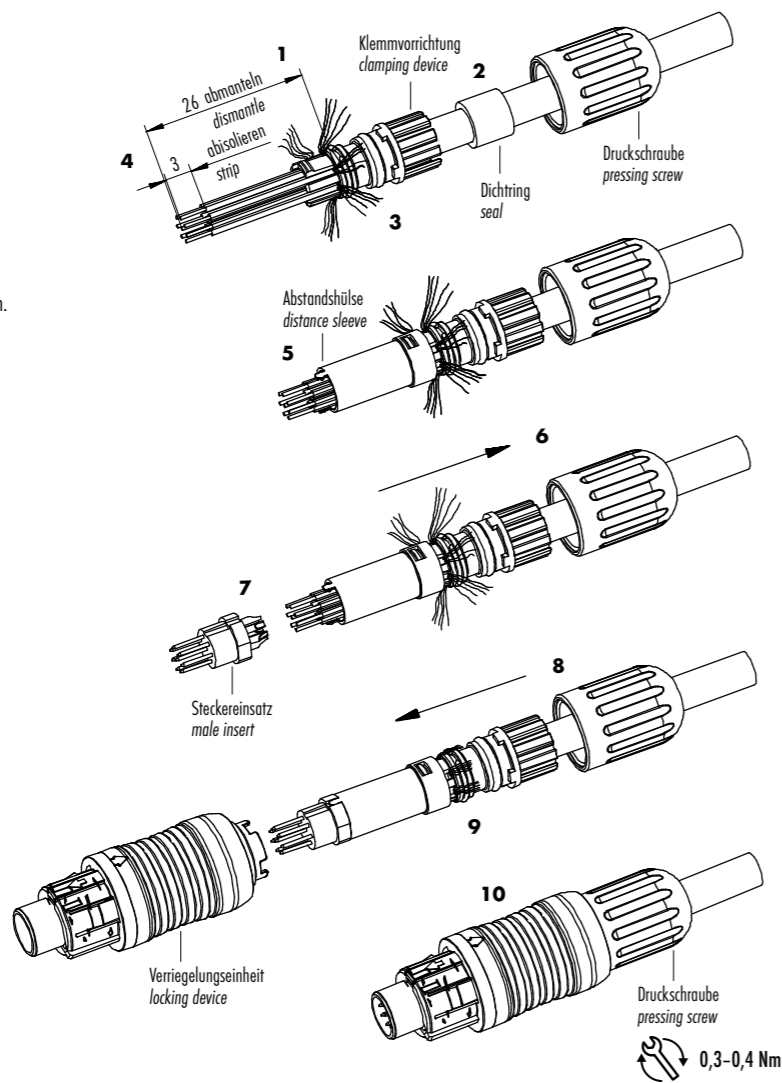

1. Strip to 26mm length but do not take off cable jacket.
2. Bead pressing screw and clamp device to cable. Mount sealing ring to clamp device. Remove cable jacket.
3. Fan out and comb shielding braid.
4. Strip the insulation off the wires and tin them.
5. Snap in distance sleeve and clamp device.
6. Solder wires to solder cups.
7. Stick distance sleeve to sleeve.
8. Push forward and snap in clamp device. Mount shielding braid around the crown.
9. Strip off and shorten shielding braid in the direction of the shielding ring.
too long: shielding braid on sealing ring - untight
too short: no contact to wave washer
10. Insert assembled unit into carrier sleeve. Note the position of the coding nose.
11. Put on and tighten pressing screw.

Einzelteildarstellung
Component part drawing

Flanschsteckverbinder
Panel mount connectors

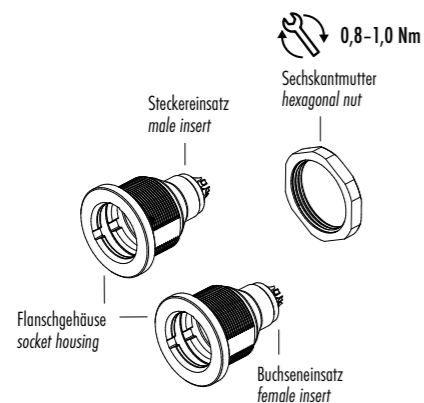

Polbilder
Contact arrangements

Stifteinsatz (Steckseite)
Male insert (mating side)

Buchseinsatz (Steckseite)
Female insert (mating side)

3 pol
3 contacts

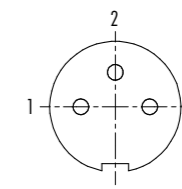
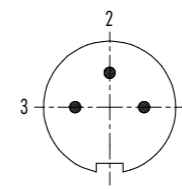

4 pol
4 contacts

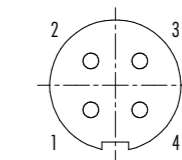
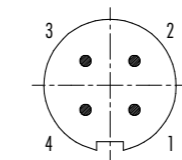

5 pol
5 contacts

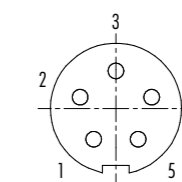
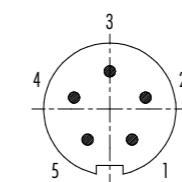

7 pol
7 contacts

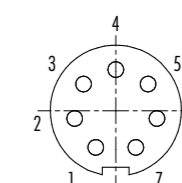
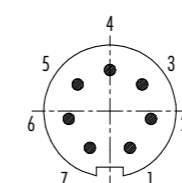

8 pol
8 contacts

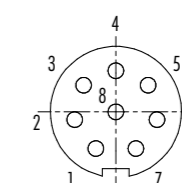
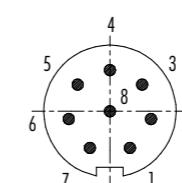

Montageausschnitt
Panel cut out

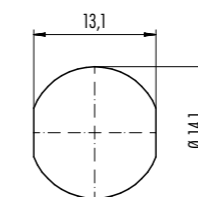

Zubehör Subminiatur 430
Accessories Subminiature

Bezeichnung / Description

Maßzeichnung / Drawing

Bestell-Nr. / Ordering-No.

Schutzkappe für Kabelsteckverbinder
Protection cap for cable connectors

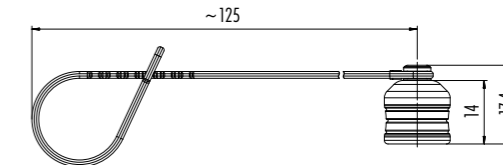

08 2965 000 000

Schutzkappe für Flanschsteckverbinder
Protection cap for panel mount connectors

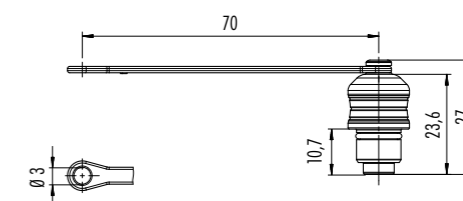

08 2966 000 000

Subminiatur

Subminiature



M9 IP40 Subminiatur

M9 IP40 Subminiature

Kabelsteckverbinder

- Schraubverriegelung M9
- 2 – 8-polig
- Schutzart IP40 ¹⁾
- Lötanschluss
- Durchmesser 11,5 mm

Flanschsteckverbinder

- Schraubverriegelung M9
- 2 – 8-polig
- Schutzart IP40 ¹⁾
- Löt-/Tauchlötanschluss
- Durchmesser 11,5 mm

Cable Connectors

- Screw termination M9
- 2 – 8 contacts
- Degree of protection IP40 ¹⁾
- Solder termination
- Diameter 11.5 mm

Panel Mount Connectors

- Screw termination M9
- 2 – 8 contacts
- Degree of protection IP40 ¹⁾
- Solder/dip solder termination
- Diameter 11.5 mm

¹⁾Erläuterung der Schutzarten siehe technische Informationen./ ¹⁾Explanation of protection standards see technical information.

Kabelstecker
Male cable connector

Kabeldose
Female cable connector

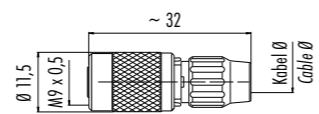
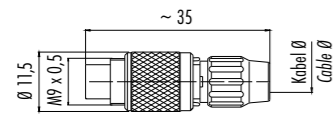

Polzahl Contacts	Kabeldurchlass 3–4 mm Cable outlet 3–4 mm	Kabeldurchlass 4–5 mm Cable outlet 4–5 mm	Polzahl Contacts	Kabeldurchlass 3–4 mm Cable outlet 3–4 mm	Kabeldurchlass 4–5 mm Cable outlet 4–5 mm
2	99 0071 100 02	99 0071 102 02	2	99 0072 100 02	99 0072 102 02
3	99 0075 100 03	99 0075 102 03	3	99 0076 100 03	99 0076 102 03
4	99 0079 100 04	99 0079 102 04	4	99 0080 100 04	99 0080 102 04
5	99 0095 100 05	99 0095 102 05	5	99 0096 100 05	99 0096 102 05
7	99 0475 100 07	99 0475 102 07	7	99 0476 100 07	99 0476 102 07
8	99 0479 100 08	99 0479 102 08	8	99 0480 100 08	99 0480 102 08

Polzahl	2	3	4	5	7	8	Number of contacts
Steckverbinder Verriegelung	schrauben/screw						Connector locking system
Anschlussart	löten/solder						Termination
Anschlussquerschnitt	max. 0,25 mm ² (max. AWG 24)			max. 0,14 mm ² (max. AWG 26)			Wire gauge
Kabeldurchlass	3–4 mm, 4–5 mm						Cable outlet
Schutzart	IP40						Degree of protection
Mechanische Lebensdauer	> 500 Steckzyklen/> 500 mating cycles						Mechanical operation
Obere Grenztemperatur	+ 85 °C						Upper temperature
Untere Grenztemperatur	– 40 °C						Lower temperature
Bemessungsspannung	125 V						Rated voltage
Bemessungs-Stoßspannung	1500 V						Rated impulse voltage
Verschmutzungsgrad	1						Pollution degree
Überspannungskategorie	II						Overvoltage categorie
Isolierstoffgruppe	III						Material group
Bemessungsstrom (40 °C)	4 A		3 A		1 A		Rated current (40 °C)
Material Kontakt	Stift/pin CuZn (Messing/brass), Buchse/socket CuSn (Bronze/bronze)						Material of contact
Kontaktoberfläche	Au (Gold/gold)						Contact plating
Material Kontaktkörper	PA/PBT						Material of contact body
Material Gehäuse	PA						Material of housing
Material Verriegelung	CuZn (Messing/brass)						Material of locking

Flanschstecker, löten
Male panel mount connector, solder

Flanschstecker, tauchlöten
Male panel mount connector, dip solder

Flanschstecker mit flexibler Leiterplatte
Male panel mount connector with flexible PCB



Bohrbilder siehe Seite 46
Drilling schemes see page 46

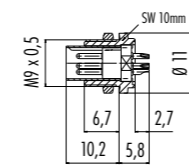

max. Wandstärke: 1,5 mm
max. wall thickness: 1,5 mm

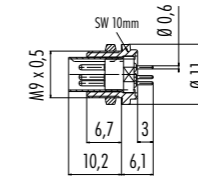

max. Wandstärke: 1,5 mm
max. wall thickness: 1,5 mm

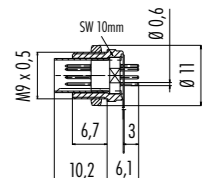

max. Wandstärke: 1,5 mm
max. wall thickness: 1,5 mm

Polzahl Contacts	Bestell-Nr. Ordering-No.	Polzahl Contacts	Bestell-Nr. Ordering-No.	Polzahl Contacts	Bestell-Nr. Ordering-No.
2	09 0073 00 02	2	09 0073 20 02	2	—
3	09 0077 00 03	3	09 0077 20 03	3	—
4	09 0081 00 04	4	09 0081 20 04	4	—
5	09 0097 00 05	5	09 0097 20 05	5	—
7	09 0477 00 07	7	09 0477 22 07	7	09 0477 65 07
8	09 0481 00 08	8	09 0481 22 08	8	09 0481 65 08

Polzahl	2	3	4	5	7	8	Number of contacts
Steckverbinder Verriegelung	schrauben/screw						Connector locking system
Anschlussart	löten/tauchlöten/solder/dip solder						Termination
Anschlussquerschnitt	max. 0,25 mm ² (max. AWG 24)/ —			max. 0,14 mm ² (max. AWG 26)/ —			Wire gauge
Kabeldurchlass	—						Cable outlet
Schutzart	IP40						Degree of protection
Mechanische Lebensdauer	> 500 Steckzyklen/> 500 mating cycles						Mechanical operation
Obere Grenztemperatur	+ 85 °C						Upper temperature
Untere Grenztemperatur	– 40 °C						Lower temperature
Bemessungsspannung	125 V						Rated voltage
Bemessungs-Stoßspannung	1500 V						Rated impulse voltage
Verschmutzungsgrad	1						Pollution degree
Überspannungskategorie	II						Overvoltage categorie
Isolierstoffgruppe	III						Material group
Bemessungsstrom (40 °C)	4 A		3 A		1 A		Rated current (40 °C)
Material Kontakt	CuZn (Messing/brass)						Material of contact
Kontaktoberfläche	Au (Gold/gold)						Contact plating
Material Kontaktkörper	PBT						Material of contact body
Material Gehäuse	CuZn (Messing vernickelt/brass nickel plated)						Material of housing
Material Verriegelung	—						Material of locking

Flanschdose, löten
Female panel mount connector, solder

Flanschdose, tauchlöten
Female panel mount connector, dip solder

Flanschdose gewinkelt, tauchlöten
Female angled panel mount connector, dip solder

Flanschdose mit flexibler Leiterplatte
Female panel mount connector with flexible PCB



Bohrbilder siehe Seite 46
Drilling schemes see page 46

Bohrbilder siehe Seite 46
Drilling schemes see page 46

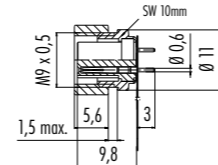
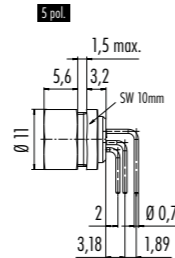
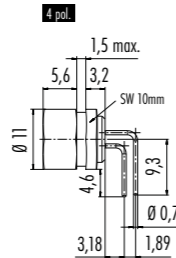
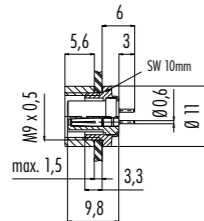
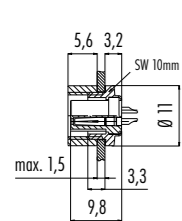

Polzahl Contacts	Bestell-Nr. Ordering-No.	Polzahl Contacts	Bestell-Nr. Ordering-No.	Polzahl Contacts	Bestell-Nr. Ordering-No.	Polzahl Contacts	Bestell-Nr. Ordering-No.
2	09 0074 00 02	2	09 0074 20 02	2	—	2	—
3	09 0078 00 03	3	09 0078 20 03	3	—	3	—
4	09 0082 00 04	4	09 0082 20 04	4	09 0082 32 04	4	—
5	09 0098 00 05	5	09 0098 20 05	5	09 0098 72 05	5	—
7	09 0478 00 07	7	09 0478 22 07	7	—	7	09 0478 65 07
8	09 0482 00 08	8	09 0482 22 08	8	—	8	09 0482 65 08

Polzahl	2	3	4	5	7	8	Number of contacts
Steckverbinder Verriegelung	schrauben/screw						Connector locking system
Anschlussart	löten/tauchlöten/solder/dip solder						Termination
Anschlussquerschnitt	max. 0,25 mm ² (max. AWG 24)/ —			max. 0,14 mm ² (max. AWG 26)/ —			Wire gauge
Kabeldurchlass	—						Cable outlet
Schutzart	IP40						Degree of protection
Mechanische Lebensdauer	> 500 Steckzyklen/> 500 mating cycles						Mechanical operation
Obere Grenztemperatur	+ 85 °C						Upper temperature
Untere Grenztemperatur	- 40 °C						Lower temperature
Bemessungsspannung	125 V						Rated voltage
Bemessungs-Stoßspannung	1500 V						Rated impulse voltage
Verschmutzungsgrad	1						Pollution degree
Überspannungskategorie	II						Overvoltage categorie
Isolierstoffgruppe	III						Material group
Bemessungsstrom (40 °C)	4 A		3 A		1 A		Rated current (40 °C)
Material Kontakt	CuSn (Bronze/bronze)						Material of contact
Kontaktoberfläche	Au (Gold/gold)						Contact plating
Material Kontaktkörper	PA						Material of contact body
Material Gehäuse	CuZn (Messing vernickelt/brass nickel plated)						Material of housing
Material Verriegelung	—						Material of locking

Montageanleitung
Assembly instruction

Kabelstecker
Male cable connector

1. Druckschraube auf Kabel auffädeln.
2. Kabel abmanteln auf L = 15 mm.
3. Litzen abisolieren und anlöten.
4. Steckereinsatz in Hülse mit Abstand t montieren.
5. Hülse mit Steckereinsatz in Trägerhalbschale Unterteil setzen.
6. Trägerhalbschale Oberteil auf Unterteil montieren.
7. Gewinding überschnappen.
8. Druckschraube festziehen.

1. Bead pressing screw to cable.
2. Dismantle cable to 15 mm length.
3. Strip and solder single wires.
3. Mount male insert into sleeve with distance t.
4. Insert sleeve with male insert into carrier sleeve part 2 (lower part grey).
5. Mount carrier sleeve part 1 (upper part black) on carrier sleeve part 2 (lower part grey).
6. Snap over coupling ring.
7. Tighten pressing screw.

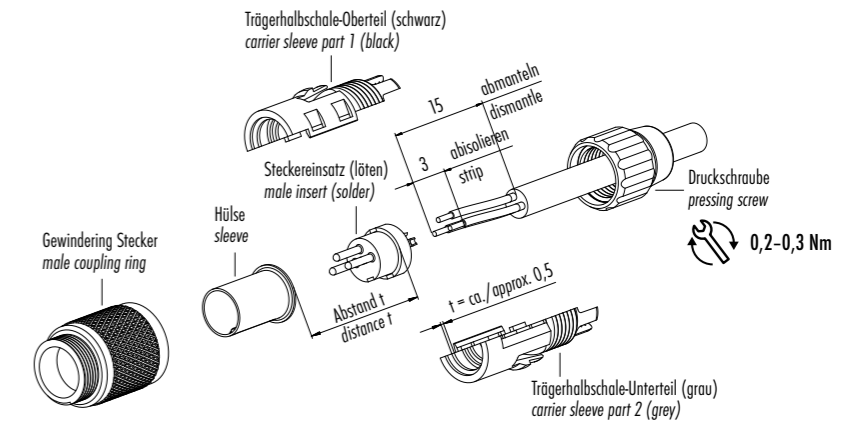

Achtung: max. Drehmoment des Gewindinges im Flanschsteckverbinder: 50cNm (handfest)
Attention: max. torque of ring nut in socket connector: 50cNm (manual adjustment)

Kabeldose
Female cable connector

1. Druckschraube auf Kabel auffädeln.
2. Kabel abmanteln auf L = 15 mm
3. Litzen abisolieren und anlöten.
4. Buchseneinsatz in Trägerhalbschale Unterteil legen.
5. Trägerhalbschale Oberteil auf Unterteil montieren.
6. Gewinding überschnappen.
7. Druckschraube festziehen.

1. Bead pressing screw to cable.
2. Dismantle cable to 15 mm length.
3. Strip and solder single wires.
4. Place female insert into carrier sleeve part 2 (lower part grey).
5. Mount carrier sleeve part 1 (upper part black) on carrier sleeve part 2 (lower part grey).
6. Snap over coupling ring.
7. Tighten pressing screw.

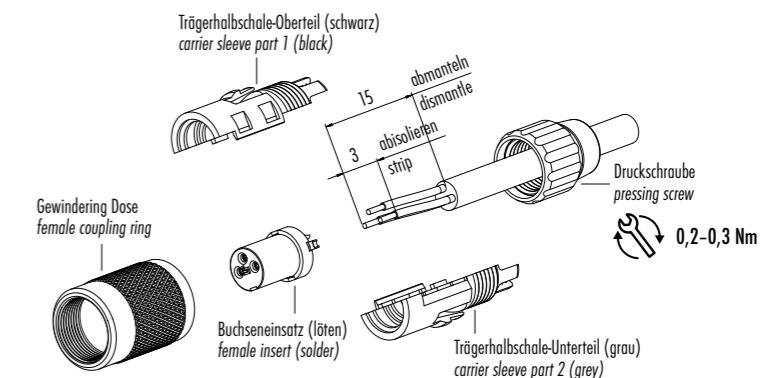

Achtung: max. Drehmoment des Gewindinges im Flanschsteckverbinder: 50cNm (handfest)
Attention: max. torque of ring nut in socket connector: 50cNm (manual adjustment)

Einzelteildarstellung
Component part drawing

Flanschsteckverbinder
Panel mount connectors

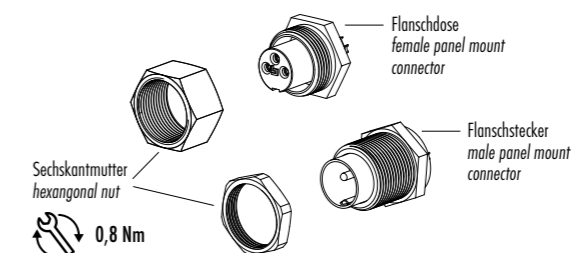

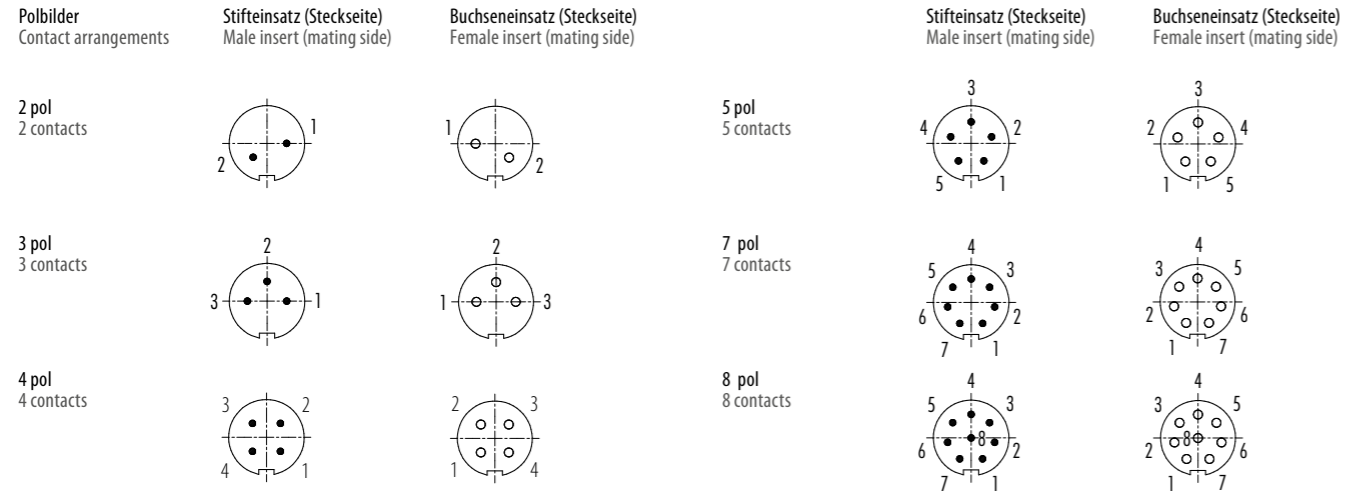

Bohrbilder Stifteinsatz (Leiterplatte)
Drilling schemes male insert (PCB)

Bohrbilder Buchseinsatz (Leiterplatte)
Drilling schemes female insert (PCB)

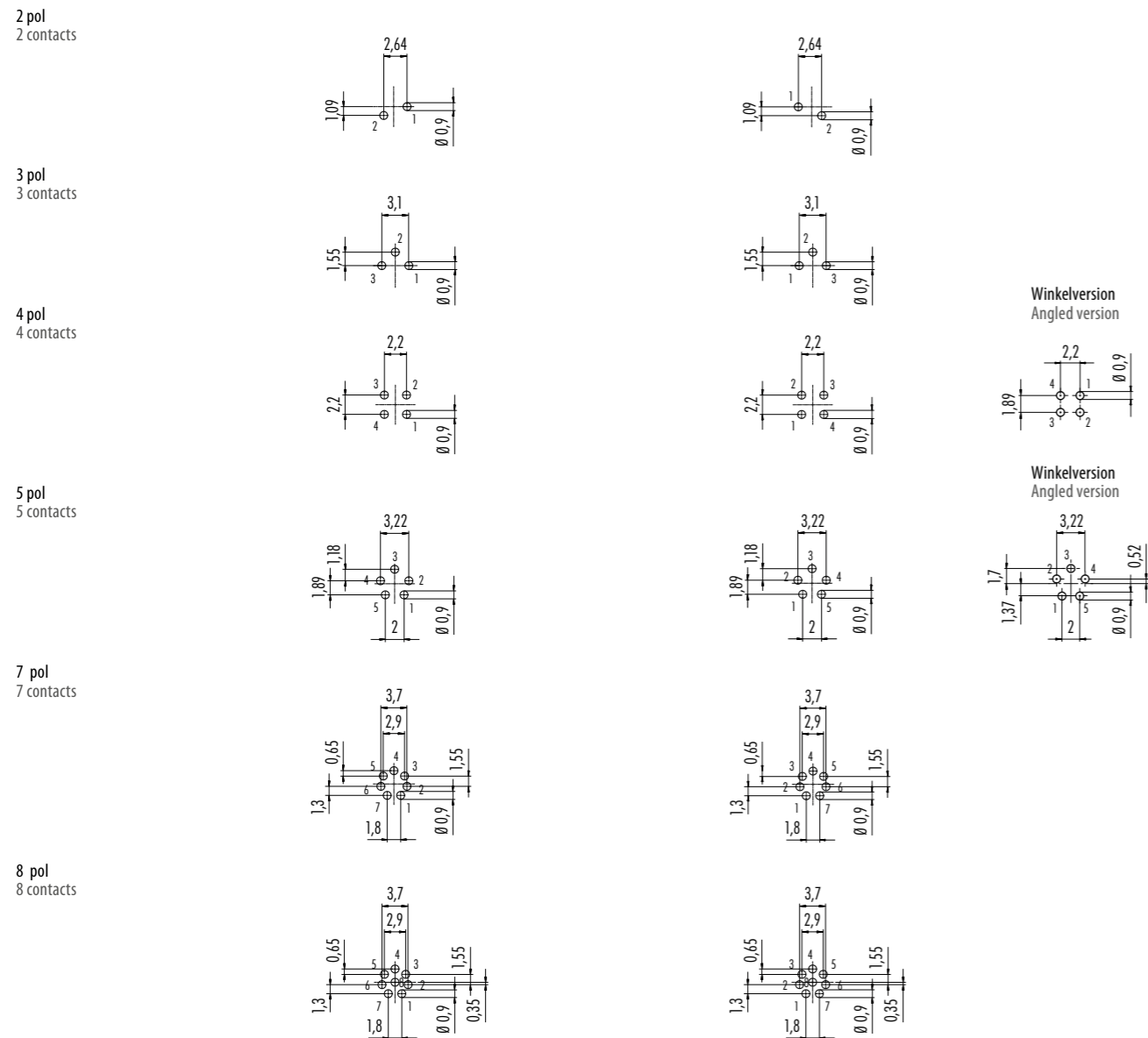

Zeichnungen
Drawings

09 0082 32 04

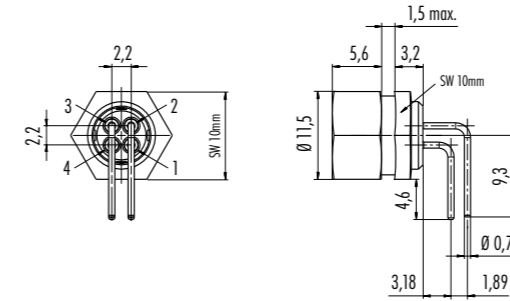

09 0098 72 05

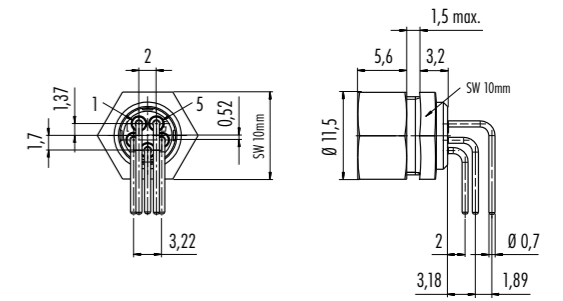

09 0477 65 07

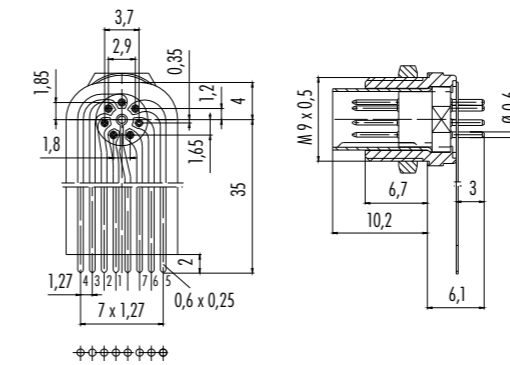

09 0481 65 08

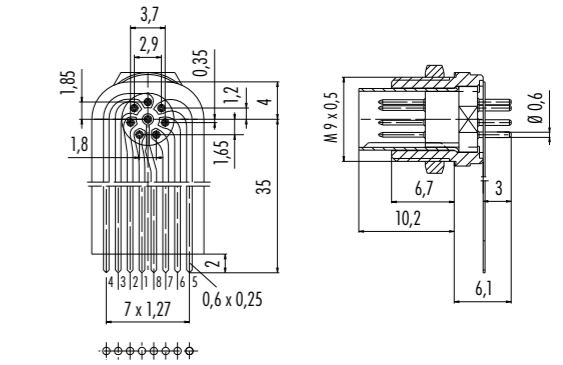

09 0478 65 07

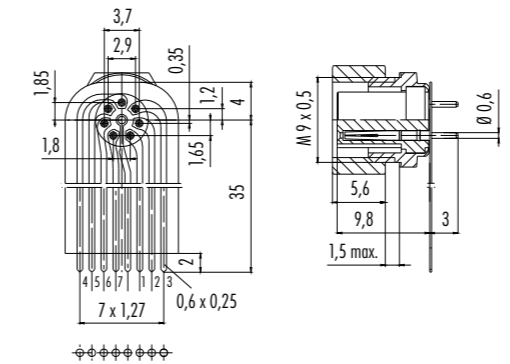

09 0482 65 08

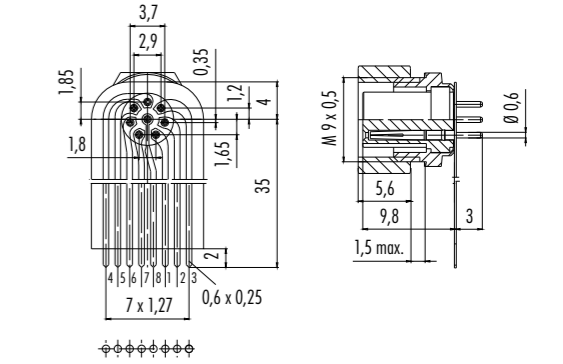

Subminiatur

Subminiature



M9 IP67 Subminiatur

M9 IP67 Subminiature

Kabelsteckverbinder

- Schraubverriegelung M9
- 2 – 8-polig
- Schutzart IP67 ¹⁾
- Lötanschluss
- Am Kabel angespritzte Ausführungen
- Durchmesser 11,5 – 14 mm
- Schirmbar

Flanschsteckverbinder

- Schraubverriegelung M9
- 2 – 8-polig
- Schutzart IP67 ¹⁾
- Löt-/Tauchlötanschluss
- Durchmesser 15 mm
- Schirmbar
- Verschiedene Bauformen

Cable Connectors

- Screw termination M9
- 2 – 8 contacts
- Degree of protection IP67 ¹⁾
- Solder termination
- Moulded versions
- Diameter 11.5 – 14 mm
- Shieldable

Panel Mount Connectors

- Screw termination M9
- 2 – 8 contacts
- Degree of protection IP67 ¹⁾
- Solder/dip solder termination
- Diameter 15 mm
- Shieldable
- Various variants

¹⁾Erläuterung der Schutzarten siehe technische Informationen./ ¹⁾Explanation of protection standards see technical information.

Kabelstecker
Male cable connector

Kabelstecker 360° EMV sicher, schirmbar
Male cable connector 360° EMI protected, shieldable

Kabelstecker, Irisfeder
Male cable connector, iris type spring

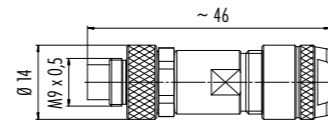
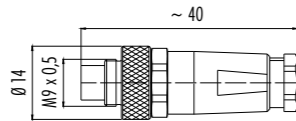
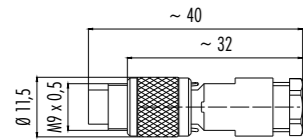

Polzahl Contacts	Kabeldurchlass Cable outlet	Bestell-Nr. Ordering-No.	Polzahl Contacts	Kabeldurchlass Cable outlet	Bestell-Nr. Ordering-No.	Polzahl Contacts	Kabeldurchlass Cable outlet	Bestell-Nr. Ordering-No.
2	3,5–5 mm	99 0401 00 02	2	3,5–5 mm	99 0401 10 02	2	4–5,5 mm	99 0401 115 02
3	3,5–5 mm	99 0405 00 03	3	3,5–5 mm	99 0405 10 03	3	4–5,5 mm	99 0405 115 03
4	3,5–5 mm	99 0409 00 04	4	3,5–5 mm	99 0409 10 04	4	4–5,5 mm	99 0409 115 04
5	3,5–5 mm	99 0413 00 05	5	3,5–5 mm	99 0413 10 05	5	4–5,5 mm	99 0413 115 05
7	3,5–5 mm	99 0421 00 07	7	3,5–5 mm	99 0421 10 07	7	4–5,5 mm	99 0421 115 07
8	3,5–5 mm	99 0425 00 08	8	3,5–5 mm	99 0425 10 08	8	4–5,5 mm	99 0425 115 08

Polzahl	2	3	4	5	7	8	Number of contacts
Steckverbinder Verriegelung	schrauben/screw						Connector locking system
Anschlussart	löten/solder						Termination
Anschlussquerschnitt	max. 0,25 mm ² (max. AWG 24)			max. 0,14 mm ² (max. AWG 26)			Wire gauge
Kabeldurchlass	3,5 –5 mm, 4 –5,5 mm						Cable outlet
Schutzart	IP67						Degree of protection
Mechanische Lebensdauer	> 500 Steckzyklen/> 500 mating cycles						Mechanical operation
Obere Grenztemperatur	+ 85 °C						Upper temperature
Untere Grenztemperatur	– 40 °C						Lower temperature
Bemessungsspannung	125 V						Rated voltage
Bemessungs-Stoßspannung	1500 V						Rated impulse voltage
Verschmutzungsgrad	1						Pollution degree
Überspannungskategorie	II						Overvoltage categorie
Isolierstoffgruppe	III						Material group
Bemessungsstrom (40 °C)	4 A		3 A		1 A		Rated current (40 °C)
Material Kontakt	CuZn (Messing/brass)						Material of contact
Kontaktoberfläche	Au (Gold/gold)						Contact plating
Material Kontaktkörper	PBT						Material of contact body
Material Gehäuse	PA, CuZn (Messing vernickelt/brass nickel plated)						Material of housing
Material Verriegelung	CuZn (Messing/brass)						Material of locking

Winkelstecker
Male angled connector

Winkelstecker 360° EMV sicher, schirmbar
Male angled connector 360° EMI protected, shieldable

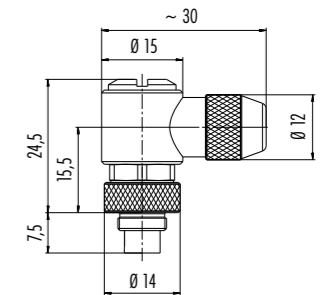
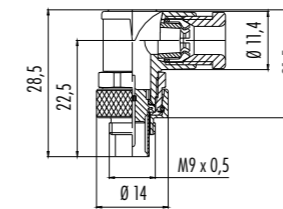

Polzahl Contacts	Kabeldurchlass Cable outlet	Bestell-Nr. Ordering-No.	Polzahl Contacts	Kabeldurchlass Cable outlet	Bestell-Nr. Ordering-No.
2	3,5–5 mm	99 0401 70 02	2	3,5–5 mm	99 0401 75 02
3	3,5–5 mm	99 0405 70 03	3	3,5–5 mm	99 0405 75 03
4	3,5–5 mm	99 0409 70 04	4	3,5–5 mm	99 0409 75 04
5	3,5–5 mm	99 0413 70 05	5	3,5–5 mm	99 0413 75 05
7	3,5–5 mm	99 0421 70 07	7	3,5–5 mm	99 0421 75 07
8	3,5–5 mm	99 0425 70 08	8	3,5–5 mm	99 0425 75 08

Polzahl	2	3	4	5	7	8	Number of contacts
Steckverbinder Verriegelung	schrauben/screw						Connector locking system
Anschlussart	löten/solder						Termination
Anschlussquerschnitt	max. 0,25 mm ² (max. AWG 24)			max. 0,14 mm ² (max. AWG 26)			Wire gauge
Kabeldurchlass	3,5 –5 mm						Cable outlet
Schutzart	IP67						Degree of protection
Mechanische Lebensdauer	> 500 Steckzyklen/> 500 mating cycles						Mechanical operation
Obere Grenztemperatur	+ 85 °C						Upper temperature
Untere Grenztemperatur	– 40 °C						Lower temperature
Bemessungsspannung	125 V						Rated voltage
Bemessungs-Stoßspannung	1500 V						Rated impulse voltage
Verschmutzungsgrad	1						Pollution degree
Überspannungskategorie	II						Overvoltage categorie
Isolierstoffgruppe	III						Material group
Bemessungsstrom (40 °C)	4 A		3 A		1 A		Rated current (40 °C)
Material Kontakt	CuZn (Messing/brass)						Material of contact
Kontaktoberfläche	Au (Gold/gold)						Contact plating
Material Kontaktkörper	PBT						Material of contact body
Material Gehäuse	PA, CuZn (Messing vernickelt/brass nickel plated)						Material of housing
Material Verriegelung	CuZn (Messing/brass)						Material of locking

Kabeldose
Female cable connector

Kabeldose 360° EMV sicher, schirmbar
Female cable connector 360° EMI protected, shieldable

Kabeldose, Irisfeder
Female cable connector, iris type spring

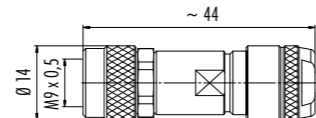
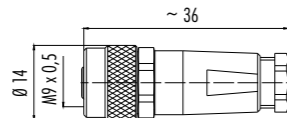
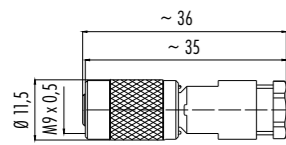

Polzahl Contacts	Kabeldurchlass Cable outlet	Bestell-Nr. Ordering-No.	Polzahl Contacts	Kabeldurchlass Cable outlet	Bestell-Nr. Ordering-No.	Polzahl Contacts	Kabeldurchlass Cable outlet	Bestell-Nr. Ordering-No.
2	3,5–5 mm	99 0402 00 02	2	3,5–5 mm	99 0402 10 02	2	4–5,5 mm	99 0402 115 02
3	3,5–5 mm	99 0406 00 03	3	3,5–5 mm	99 0406 10 03	3	4–5,5 mm	99 0406 115 03
4	3,5–5 mm	99 0410 00 04	4	3,5–5 mm	99 0410 10 04	4	4–5,5 mm	99 0410 115 04
5	3,5–5 mm	99 0414 00 05	5	3,5–5 mm	99 0414 10 05	5	4–5,5 mm	99 0414 115 05
7	3,5–5 mm	99 0422 00 07	7	3,5–5 mm	99 0422 10 07	7	4–5,5 mm	99 0422 115 07
8	3,5–5 mm	99 0426 00 08	8	3,5–5 mm	99 0426 10 08	8	4–5,5 mm	99 0426 115 08

Polzahl	2	3	4	5	7	8	Number of contacts
Steckverbinder Verriegelung	schrauben/screw						Connector locking system
Anschlussart	löten/solder						Termination
Anschlussquerschnitt	max. 0,25 mm ² (max. AWG 24)			max. 0,14 mm ² (max. AWG 26)			Wire gauge
Kabeldurchlass	3,5 –5 mm, 4 –5,5 mm						Cable outlet
Schutzart	IP67						Degree of protection
Mechanische Lebensdauer	> 500 Steckzyklen/> 500 mating cycles						Mechanical operation
Obere Grenztemperatur	+ 85 °C						Upper temperature
Untere Grenztemperatur	– 40 °C						Lower temperature
Bemessungsspannung	125 V						Rated voltage
Bemessungs-Stoßspannung	1500 V						Rated impulse voltage
Verschmutzungsgrad	1						Pollution degree
Überspannungskategorie	II						Overvoltage categorie
Isolierstoffgruppe	III						Material group
Bemessungsstrom (40°C)	4 A		3 A		1 A		Rated current (40 °C)
Material Kontakt	CuSn (Bronze/bronze)						Material of contact
Kontaktoberfläche	Au (Gold/gold)						Contact plating
Material Kontaktkörper	PA						Material of contact body
Material Gehäuse	PA, CuZn (Messing vernickelt/brass nickel plated)						Material of housing
Material Verriegelung	CuZn (Messing/brass)						Material of locking

Winkeldose
Female angled connector

Winkeldose 360° EMV sicher, schirmbar
Female angled connector 360° EMI protected, shieldable

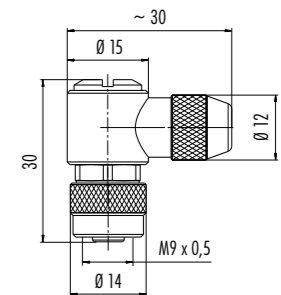
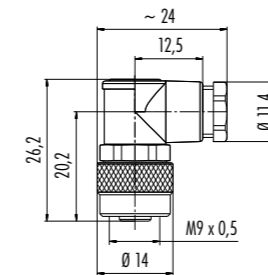

Polzahl Contacts	Kabeldurchlass Cable outlet	Bestell-Nr. Ordering-No.	Polzahl Contacts	Kabeldurchlass Cable outlet	Bestell-Nr. Ordering-No.
2	3,5–5 mm	99 0402 70 02	2	3,5–5 mm	99 0402 75 02
3	3,5–5 mm	99 0406 70 03	3	3,5–5 mm	99 0406 75 03
4	3,5–5 mm	99 0410 70 04	4	3,5–5 mm	99 0410 75 04
5	3,5–5 mm	99 0414 70 05	5	3,5–5 mm	99 0414 75 05
7	3,5–5 mm	99 0422 70 07	7	3,5–5 mm	99 0422 75 07
8	3,5–5 mm	99 0426 70 08	8	3,5–5 mm	99 0426 75 08

Polzahl	2	3	4	5	7	8	Number of contacts
Steckverbinder Verriegelung	schrauben/screw						Connector locking system
Anschlussart	löten/solder						Termination
Anschlussquerschnitt	max. 0,25 mm ² (max. AWG 24)			max. 0,14 mm ² (max. AWG 26)			Wire gauge
Kabeldurchlass	3,5 –5 mm						Cable outlet
Schutzart	IP67						Degree of protection
Mechanische Lebensdauer	> 500 Steckzyklen/> 500 mating cycles						Mechanical operation
Obere Grenztemperatur	+ 85 °C						Upper temperature
Untere Grenztemperatur	– 40 °C						Lower temperature
Bemessungsspannung	125 V						Rated voltage
Bemessungs-Stoßspannung	1500 V						Rated impulse voltage
Verschmutzungsgrad	1						Pollution degree
Überspannungskategorie	II						Overvoltage categorie
Isolierstoffgruppe	III						Material group
Bemessungsstrom (40°C)	4 A		3 A		1 A		Rated current (40 °C)
Material Kontakt	CuZn (Messing/brass)						Material of contact
Kontaktoberfläche	Au (Gold/gold)						Contact plating
Material Kontaktkörper	PA						Material of contact body
Material Gehäuse	PA, CuZn (Messing vernickelt/brass nickel plated)						Material of housing
Material Verriegelung	CuZn (Messing/brass)						Material of locking

Flanschstecker, löten
Male panel mount connector, solder

Flanschstecker, löten, von vorn verschraubbar
Male panel mount connector, solder, front fastened

Flanschstecker, tauchlöten, von vorn verschraubbar
Male panel mount connector, dip solder, front fastened

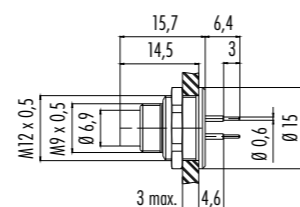
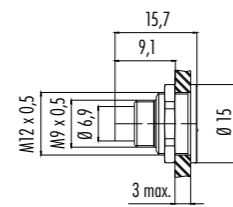
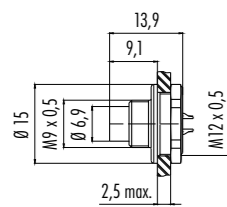

Polzahl Contacts	Bestell-Nr. Ordering-No.
2	09 0403 00 02
3	09 0407 00 03
4	09 0411 00 04
5	09 0415 00 05
7	09 0423 00 07
8	09 0427 00 08

Polzahl Contacts	Bestell-Nr. Ordering-No.
2	09 0403 80 02
3	09 0407 80 03
4	09 0411 80 04
5	09 0415 80 05
7	09 0423 80 07
8	09 0427 80 08

Polzahl Contacts	Bestell-Nr. Ordering-No.
2	09 0403 90 02
3	09 0407 90 03
4	09 0411 90 04
5	09 0415 90 05
7	09 0423 90 07
8	09 0427 90 08

Polzahl	2	3	4	5	7	8	Number of contacts
Steckverbinder Verriegelung	schrauben/screw						Connector locking system
Anschlussart	löten/tauchlöten/solder/dip solder						Termination
Anschlussquerschnitt	max. 0,25 mm ² (max. AWG 24)/ —			max. 0,14 mm ² (max. AWG 26)/ —			Wire gauge
Kabeldurchlass	—						Cable outlet
Schutzart	IP67						Degree of protection
Mechanische Lebensdauer	> 500 Steckzyklen/> 500 mating cycles						Mechanical operation
Obere Grenztemperatur	+ 85 °C						Upper temperature
Untere Grenztemperatur	- 40 °C						Lower temperature
Bemessungsspannung	125 V						Rated voltage
Bemessungs-Stoßspannung	1500 V						Rated impulse voltage
Verschmutzungsgrad	1						Pollution degree
Überspannungskategorie	II						Overvoltage categorie
Isolierstoffgruppe	III						Material group
Bemessungsstrom (40°C)	4 A		3 A		1 A		Rated current (40 °C)
Material Kontakt	CuZn (Messing/brass)						Material of contact
Kontaktoberfläche	Au (Gold/gold)						Contact plating
Material Kontaktkörper	PBT						Material of contact body
Material Gehäuse	CuZn (Messing vernickelt/brass nickel plated)						Material of housing
Material Verriegelung	—						Material of locking

Flanschstecker, tauchlöten, von vorn verschraubbar,
Schirmblech 6 mm
Male panel mount connector, dip solder, front fastened,
shielding sheet 6 mm

Flanschstecker, tauchlöten, von vorn verschraubbar,
Schirmblech 10 mm
Male panel mount connector, dip solder, front fastened,
shielding sheet 10 mm

Flanschstecker mit flexibler Leiterplatte
Male panel mount connector with flexible PCB



Bohrbilder siehe Seite 65
Drilling schemes see page 65

Bohrbilder siehe Seite 65
Drilling schemes see page 65

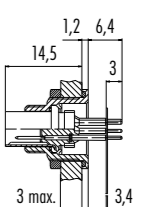
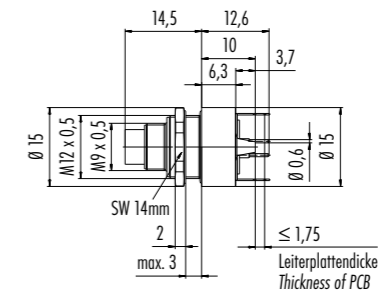
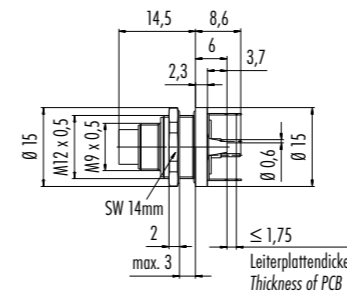

Polzahl Contacts	Bestell-Nr. Ordering-No.
2	09 0403 30 02
3	09 0407 30 03
4	09 0411 30 04
5	09 0415 30 05
7	09 0423 30 07
8	09 0427 30 08

Polzahl Contacts	Bestell-Nr. Ordering-No.
2	09 0403 35 02
3	09 0407 35 03
4	09 0411 35 04
5	09 0415 35 05
7	09 0423 35 07
8	09 0427 35 08

Polzahl Contacts	Bestell-Nr. Ordering-No.
2	—
3	—
4	—
5	—
7	09 0423 65 07
8	09 0427 65 08

Polzahl	2	3	4	5	7	8	Number of contacts
Steckverbinder Verriegelung	schrauben/screw						Connector locking system
Anschlussart	löten/tauchlöten/solder/dip solder						Termination
Anschlussquerschnitt	—						Wire gauge
Kabeldurchlass	—						Cable outlet
Schutzart	IP67						Degree of protection
Mechanische Lebensdauer	> 500 Steckzyklen/> 500 mating cycles						Mechanical operation
Obere Grenztemperatur	+ 85 °C						Upper temperature
Untere Grenztemperatur	- 40 °C						Lower temperature
Bemessungsspannung	125 V						Rated voltage
Bemessungs-Stoßspannung	1500 V						Rated impulse voltage
Verschmutzungsgrad	1						Pollution degree
Überspannungskategorie	II						Overvoltage categorie
Isolierstoffgruppe	III						Material group
Bemessungsstrom (40°C)	4 A		3 A		1 A		Rated current (40 °C)
Material Kontakt	CuZn (Messing/brass)						Material of contact
Kontaktoberfläche	Au (Gold/gold)						Contact plating
Material Kontaktkörper	PBT						Material of contact body
Material Gehäuse	CuZn (Messing vernickelt/brass nickel plated)						Material of housing
Material Verriegelung	—						Material of locking

Flanschdose, löten
Female panel mount connector, solder

Flanschdose, löten, von vorn verschraubbar
Female panel mount connector, solder, front fastened

Flanschdose, tauchlöten, von vorn verschraubbar
Female panel mount connector, dip solder, front fastened

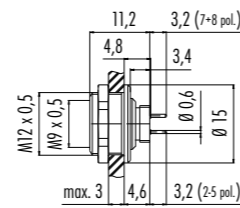
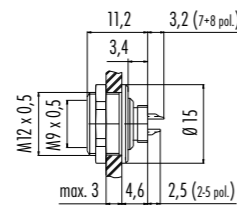
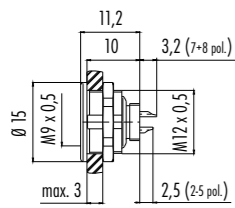

Polzahl Contacts	Bestell-Nr. Ordering-No.
2	09 0404 00 02
3	09 0408 00 03
4	09 0412 00 04
5	09 0416 00 05
7	09 0424 00 07
8	09 0428 00 08

Polzahl Contacts	Bestell-Nr. Ordering-No.
2	09 0404 80 02
3	09 0408 80 03
4	09 0412 80 04
5	09 0416 80 05
7	09 0424 80 07
8	09 0428 80 08

Polzahl Contacts	Bestell-Nr. Ordering-No.
2	09 0404 90 02
3	09 0408 90 03
4	09 0412 90 04
5	09 0416 90 05
7	09 0424 90 07
8	09 0428 90 08

Polzahl	2	3	4	5	7	8	Number of contacts
Steckverbinder Verriegelung	schrauben/screw						Connector locking system
Anschlussart	löten/tauchlöten/solder/dip solder						Termination
Anschlussquerschnitt	max. 0,25 mm ² (max. AWG 24)/ —			max. 0,14 mm ² (max. AWG 26)/ —			Wire gauge
Kabeldurchlass	—						Cable outlet
Schutzart	IP67						Degree of protection
Mechanische Lebensdauer	> 500 Steckzyklen/> 500 mating cycles						Mechanical operation
Obere Grenztemperatur	+ 85 °C						Upper temperature
Untere Grenztemperatur	- 40 °C						Lower temperature
Bemessungsspannung	125 V						Rated voltage
Bemessungs-Stoßspannung	1500 V						Rated impulse voltage
Verschmutzungsgrad	1						Pollution degree
Überspannungskategorie	II						Overvoltage categorie
Isolierstoffgruppe	III						Material group
Bemessungsstrom (40°C)	4 A		3 A		1 A		Rated current (40 °C)
Material Kontakt	CuSn (Bronze/bronze)						Material of contact
Kontaktoberfläche	Au (Gold/gold)						Contact plating
Material Kontaktkörper	PA						Material of contact body
Material Gehäuse	CuZn (Messing vernickelt/brass nickel plated)						Material of housing
Material Verriegelung	—						Material of locking

Flanschdose, tauchlöten, von vorn verschraubbar, Schirmblech 6 mm
Female panel mount connector, dip solder, front fastened, shielding sheet 6 mm

Flanschdose, tauchlöten, von vorn verschraubbar, Schirmblech 10 mm
Female panel mount connector, dip solder, front fastened, shielding sheet 10 mm

Flanschdose gewinkelt, tauchlöten, von vorn verschraubbar, Schirmblech
Female angled panel mount connector, dip solder, front fastened, shielding sheet

Flanschdose mit flexibler Leiterplatte
Female panel mount connector with flexible PCB



Bohrbilder siehe Seite 65
Drilling schemes see page 65

Bohrbilder siehe Seite 65
Drilling schemes see page 65

Bohrbilder siehe Seite 65
Drilling schemes see page 65

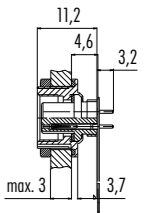
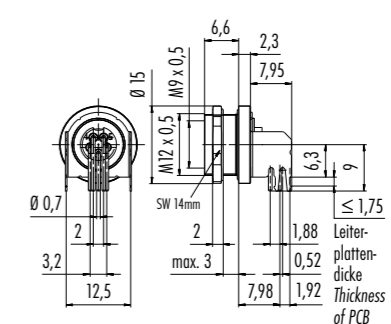
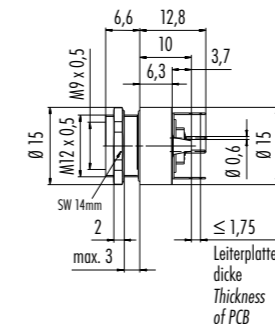
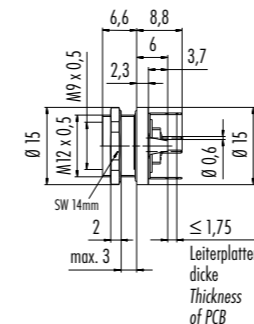

Polzahl Contacts	Bestell-Nr. Ordering-No.
2	09 0404 30 02
3	09 0408 30 03
4	09 0412 30 04
5	09 0416 30 05
7	09 0424 30 07
8	09 0428 30 08

Polzahl Contacts	Bestell-Nr. Ordering-No.
2	09 0404 35 02
3	09 0408 35 03
4	09 0412 35 04
5	09 0416 35 05
7	09 0424 35 07
8	09 0428 35 08

Polzahl Contacts	Bestell-Nr. Ordering-No.
2	09 0404 55 02
3	—
4	—
5	09 0416 55 05
7	—
8	—

Polzahl Contacts	Bestell-Nr. Ordering-No.
2	—
3	—
4	—
5	—
7	09 0424 65 07
8	09 0428 65 08

Polzahl	2	3	4	5	7	8	Number of contacts
Steckverbinder Verriegelung	Bajonett/bayonet						Connector locking system
Anschlussart	tauchlöten/dip solder						Termination
Anschlussquerschnitt	—						Wire gauge
Kabeldurchlass	—						Cable outlet
Schutzart	IP67						Degree of protection
Mechanische Lebensdauer	> 500 Steckzyklen/> 500 mating cycles						Mechanical operation
Obere Grenztemperatur	+ 85 °C						Upper temperature
Untere Grenztemperatur	- 40 °C						Lower temperature
Bemessungsspannung	125 V						Rated voltage
Bemessungs-Stoßspannung	1500 V						Rated impulse voltage
Verschmutzungsgrad	1						Pollution degree
Überspannungskategorie	II						Overvoltage categorie
Isolierstoffgruppe	III						Material group
Bemessungsstrom (40°C)	4 A		3 A		1 A		Rated current (40 °C)
Material Kontakt	CuSn (Bronze/bronze)						Material of contact
Kontaktoberfläche	Au (Gold/gold)						Contact plating
Material Kontaktkörper	PBT						Material of contact body
Material Gehäuse	CuZn (Messing vernickelt/brass nickel plated)						Material of housing
Material Verriegelung	—						Material of locking

Kabelstecker, umspritzt, ungeschirmt
Male cable connector, moulded, unshielded

Winkelstecker, umspritzt, ungeschirmt
Male angled connector, moulded, unshielded

Kabeldose, umspritzt, ungeschirmt
Female cable connector, moulded, unshielded

Winkeldose, umspritzt, ungeschirmt
Female angled connector, moulded, unshielded

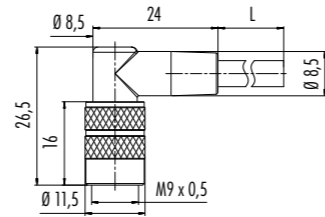
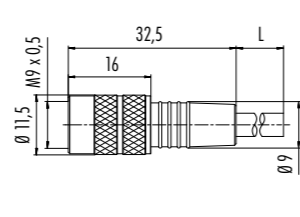
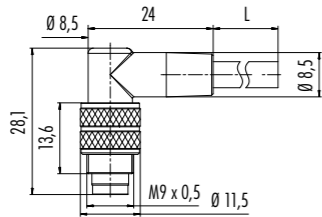
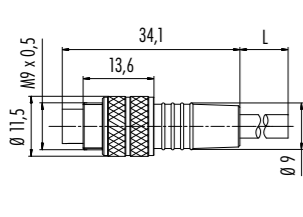

Polzahl Contacts	Kabellänge 2 m Cable length 2 m	Kabellänge 5 m Cable length 5 m	Polzahl Contacts	Kabellänge 2 m Cable length 2 m	Kabellänge 5 m Cable length 5 m	Polzahl Contacts	Kabellänge 2 m Cable length 2 m	Kabellänge 5 m Cable length 5 m	Polzahl Contacts	Kabellänge 2 m Cable length 2 m	Kabellänge 5 m Cable length 5 m
3	79 1451 212 03	79 1451 215 03	3	79 1451 272 03	79 1451 275 03	3	79 1452 212 03	79 1452 215 03	3	79 1452 272 03	79 1452 275 03
5	79 1455 212 05	79 1455 215 05	5	79 1455 272 05	79 1455 275 05	5	79 1456 212 05	79 1456 215 05	5	79 1456 272 05	79 1456 275 05
8	79 1461 212 08	79 1461 215 08	8	79 1461 272 08	79 1461 275 08	8	79 1462 212 08	79 1462 215 08	8	79 1462 272 08	79 1462 275 08

Technische Daten Kabel	3	5	7	Specifications of cable
Querschnitt mm ² ¹⁾	3 x 0,25 mm ² (AWG 24)	5 x 0,25 mm ² (AWG 24)	8 x 0,14 mm ² (AWG 26)	Wire gauge mm ² ¹⁾
Material Mantel	PUR			Material jacket
Isolation Litze	PVC		PVC/PE	Insulation wire
Litzenaufbau (mm)	32 x 0,1		18 x 0,1	Design of wire (mm)
Kabelmantel Ø (mm)	4,5 ^{+0,2}	5 ^{+0,2}		Cable jacket Ø (mm)
Leiterwiderstand	72 Ω/Km (20 °C)	77,5 Ω/Km (20 °C)	117 Ω/Km (20 °C)	Resistance of wire
Temp.-Bereich (Kabel bew.)	- 5 °C /+ 70 °C			Temp. range (cable in move)
Temp.-Bereich (Kabel fest)	- 25 °C /+ 70 °C			Temp. range (cable fixed)
Biegeradius (Kabel bew.)	min. 45 mm	min. 50 mm		Bending radius (cable in move)
Biegeradius (Kabel fest)	min. 22 mm	min. 25 mm		Bending radius (cable fixed)
Zulassung	—			Approval

Polzahl	3	5	8	Number of contacts
Steckverbinder Verriegelung	schrauben/screw			Connector locking system
Anschlussart	am Kabel angespritzt/moulded			Termination
Anschlussquerschnitt	0,25 mm ² (AWG 24)		0,14 mm ² (AWG 26)	Wire gauge
Kabeldurchlass	—			Cable outlet
Schutzart	IP67			Degree of protection
Mechanische Lebensdauer	> 500 Steckzyklen/> 500 mating cycles			Mechanical operation
Obere Grenztemperatur	+ 85 °C			Upper temperature
Untere Grenztemperatur	- 25 °C			Lower temperature
Bemessungsspannung	125 V			Rated voltage
Bemessungs-Stoßspannung	1500 V			Rated impulse voltage
Verschmutzungsgrad	1			Pollution degree
Überspannungskategorie	II			Overvoltage categorie
Isolierstoffgruppe	III			Material group
Bemessungsstrom (40 °C)	4 A	3 A	1 A	Rated current (40 °C)
Material Kontakt	CuZn (Messing/brass)			Material of contact
Kontaktoberfläche	Au (Gold/gold)			Contact plating
Material Kontaktkörper	PBT			Material of contact body
Material Gehäuse	PUR			Material of housing
Material Verriegelung	CuZn (Messing/brass)			Material of locking

Kabelstecker, umspritzt, geschirmt
Male cable connector, moulded, shielded

Winkelstecker, umspritzt, geschirmt
Male angled connector, moulded, shielded

Kabeldose, umspritzt, geschirmt
Female cable connector, moulded, shielded

Winkeldose, umspritzt, geschirmt
Female angled connector, moulded, shielded

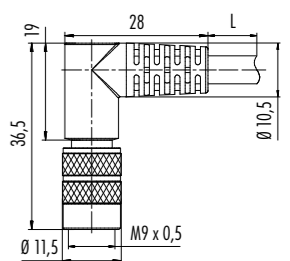
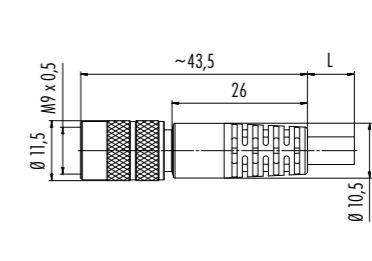
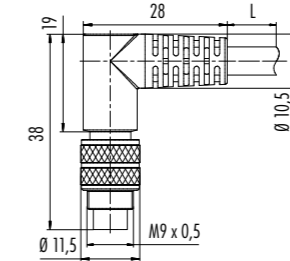
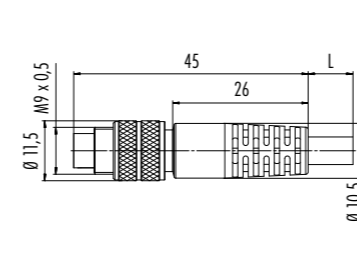

Polzahl Contacts	Kabellänge 2 m Cable length 2 m	Kabellänge 5 m Cable length 5 m	Polzahl Contacts	Kabellänge 2 m Cable length 2 m	Kabellänge 5 m Cable length 5 m	Polzahl Contacts	Kabellänge 2 m Cable length 2 m	Kabellänge 5 m Cable length 5 m	Polzahl Contacts	Kabellänge 2 m Cable length 2 m	Kabellänge 5 m Cable length 5 m
2	79 1401 12 02	79 1401 15 02	2	79 1401 72 02	79 1401 75 02	2	79 1402 12 02	79 1402 15 02	2	79 1402 72 02	79 1402 75 02
3	79 1405 12 03	79 1405 15 03	3	79 1405 72 03	79 1405 75 03	3	79 1406 12 03	79 1406 15 03	3	79 1406 72 03	79 1406 75 03
4	79 1409 12 04	79 1409 15 04	4	79 1409 72 04	79 1409 75 04	4	79 1410 12 04	79 1410 15 04	4	79 1410 72 04	79 1410 75 04
5	79 1413 12 05	79 1413 15 05	5	79 1413 72 05	79 1413 75 05	5	79 1414 12 05	79 1414 15 05	5	79 1414 72 05	79 1414 75 05
7	79 1421 12 07	79 1421 15 07	7	79 1421 72 07	79 1421 75 07	7	79 1422 12 07	79 1422 15 07	7	79 1422 72 07	79 1422 75 07
8	79 1425 12 08	79 1425 15 08	8	79 1425 72 08	79 1425 75 08	8	79 1426 12 08	79 1426 15 08	8	79 1426 72 08	79 1426 75 08

Technische Daten Kabel	2	3	4	5	7	8	Specifications of cable
Querschnitt mm ² ¹⁾	5 x 0,25 mm ² (AWG 24)			8 x 0,14 mm ² (AWG 26)			Wire gauge mm ² ¹⁾
Material Mantel	PUR						Material jacket
Isolation Litze	PP			PVC			Insulation wire
Litzenaufbau (mm)	32 x 0,1			18 x 0,1			Design of wire (mm)
Kabelmantel Ø (mm)	4,8 ^{+0,15}			5,4 ^{+0,2}			Cable jacket Ø (mm)
Leiterwiderstand	< 79 Ω/Km (20 °C)			< 148 Ω/Km (20 °C)			Resistance of wire
Temp.-Bereich (Kabel bew.)	- 25 °C /+ 90 °C			- 5 °C /+ 80 °C			Temp. range (cable in move)
Temp.-Bereich (Kabel fest)	- 50 °C /+ 90 °C			- 25 °C /+ 80 °C			Temp. range (cable fixed)
Biegeradius (Kabel bew.)	48 mm			405 mm			Bending radius (cable in move)
Biegeradius (Kabel fest)	24 mm			80 mm			Bending radius (cable fixed)
Zulassung	UL						Approval

Polzahl	2	3	4	5	7	8	Number of contacts
Steckverbinder Verriegelung	schrauben/screw						Connector locking system
Anschlussart	am Kabel angespritzt/moulded						Termination
Anschlussquerschnitt	0,25 mm ² (AWG 24)			0,14 mm ² (AWG 26)			Wire gauge
Kabeldurchlass	—						Cable outlet
Schutzart	IP67						Degree of protection
Mechanische Lebensdauer	> 500 Steckzyklen/> 500 mating cycles						Mechanical operation
Obere Grenztemperatur	+ 85 °C						Upper temperature
Untere Grenztemperatur	- 25 °C						Lower temperature
Bemessungsspannung	125 V						Rated voltage
Bemessungs-Stoßspannung	1500 V						Rated impulse voltage
Verschmutzungsgrad	1						Pollution degree
Überspannungskategorie	II						Overvoltage categorie
Isolierstoffgruppe	III						Material group
Bemessungsstrom (40 °C)	4 A		3 A		1 A		Rated current (40 °C)
Material Kontakt	CuZn (Messing/brass)						Material of contact
Kontaktoberfläche	Au (Gold/gold)						Contact plating
Material Kontaktkörper	PBT						Material of contact body
Material Gehäuse	PUR						Material of housing
Material Verriegelung	CuZn (Messing/brass)						Material of locking

Montageanleitung
Assembly instruction

Gerade Kunststoffausführung
Straight plastic version

1. Druckschraube, Klemmkorb, Dichtring und Schnapphülse auf Kabel auffädeln.
2. Kabel abmanteln auf L = min. 10 bis max. 12 mm.
3. Litzen abisolieren und anlöten.
4. Schnapphülse mit Kontakteinsatz verschrauben.
5. Montierter Teil in Gewinding schieben und Gewinding mit Schnapphülse verschrauben.
6. Dichtring und Klemmkorb in Schnapphülse schieben und Druckschraube festziehen.
7. Gewinding auf Schnapphülse aufsnappen.

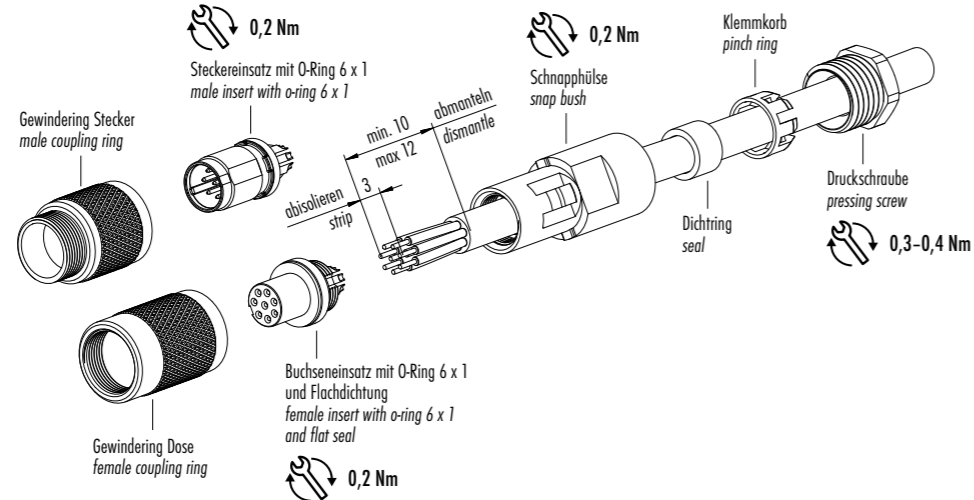

1. Bead pressing screw, pinch ring, seal and snap bush to cable.
2. Dismantle cable to min. 10 and max 12 mm length.
3. Strip and solder single wires.
4. Screw snap bush with contact insert.
5. Push the assembled part into the coupling ring and screw the coupling ring with the snap bush.
6. Push seal and pinch ring into snap bush and tighten pressing screw.
7. Snap coupling ring onto snap bush.

Gerade Metallausführung, EMV
Straight metal version, EMI

1. Kupplungshülse, Dichtring, Klemmkorb und Druckschraube auf Kabel auffädeln.
2. Kabel abmanteln auf L = min. 10 bis max. 12 mm.
3. Litzen abisolieren.
4. Schirm umlegen, Schirmmanschette an Kabeldurchmesser anpassen und mit Schirm verlöten. Überstehendes Geflecht abschneiden.
5. Litzen anlöten.
6. Kupplungshülse auf montierten Kontakteinsatz schrauben.
7. Druckschraube festziehen.

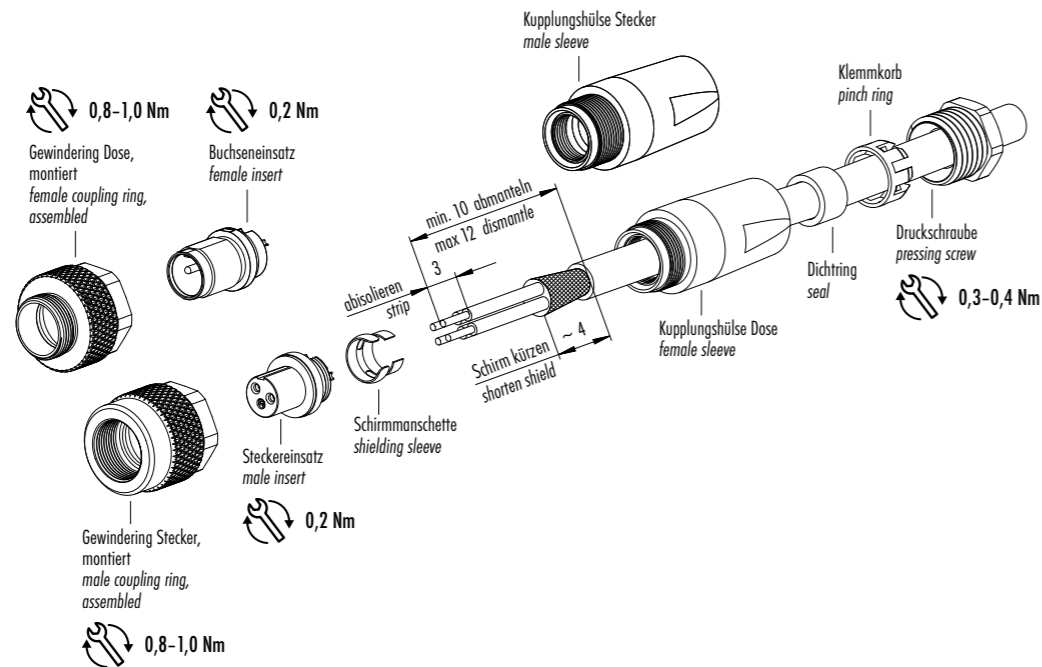

1. Bead male/female sleeve, seal, pinch ring and pressing screw to cable.
2. Dismantle cable to min. 10 and max 12 mm length.
3. Strip single wires.
4. Fold shield back, adjust shielding sleeve to cable diameter and solder it to shield. Cut off projecting shielding braid.
5. Solder single wires.
6. Screw the sleeve onto the assembled contact insert.
7. Tighten pressing screw.

Montageanleitung
Assembly instruction

Gerade Metallausführung, EMV Ausführung mit Irisfeder-Schirmung
Straight metal version, EMI version with iris type spring

Schirmdurchmesser > 3,5 mm

1. Gehäuse auf Kabel auffädeln.
2. Litzen abisolieren, Schirm kürzen.
3. Litzen anlöten.
4. Gehäuse mit Kontakteinsatz verschrauben und Druckschraube festdrehen.

Shield-diameter > 3,5 mm

1. Bead housing to cable.
2. Strip single wires, shorten shielding braid.
3. Solder single wires.
4. Screw housing to contact insert and fix pressing screw.

Schirmdurchmesser > 3,5 mm
Shield-diameter > 3,5 mm

0,8-1,0 Nm

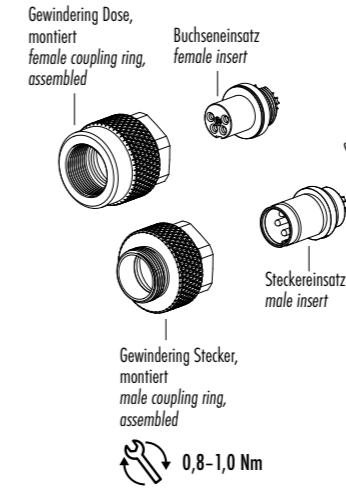

Kabeldurchlass 4-5,5 mm
Cable outlet 4-5,5 mm

Schirmdurchmesser ≤ 3,5 mm

1. Gehäuse auf Kabel auffädeln.
2. Abisolieren, Schirm kürzen, Schirm über Kabelmantel legen, mit Kupfer-Schirmfolie ca. 1 1/2 mal umwickeln und die Folie kürzen.
3. Litzen anlöten.
4. Gehäuse mit Kontakteinsatz verschrauben und Druckschraube festdrehen.

Shield-diameter ≤ 3,5 mm

1. Bead housing to cable.
2. Strip single cores, shorten shielding braid, put braid over cable coating, wrap it approx. 1 1/2 times with shielded copper tape and shorten tape.
3. Solder wires.
4. Screw housing to male or female contact carrier and fix pressing screw.

Schirmdurchmesser ≤ 3,5 mm
Shield-diameter ≤ 3,5 mm

0,8-1,0 Nm

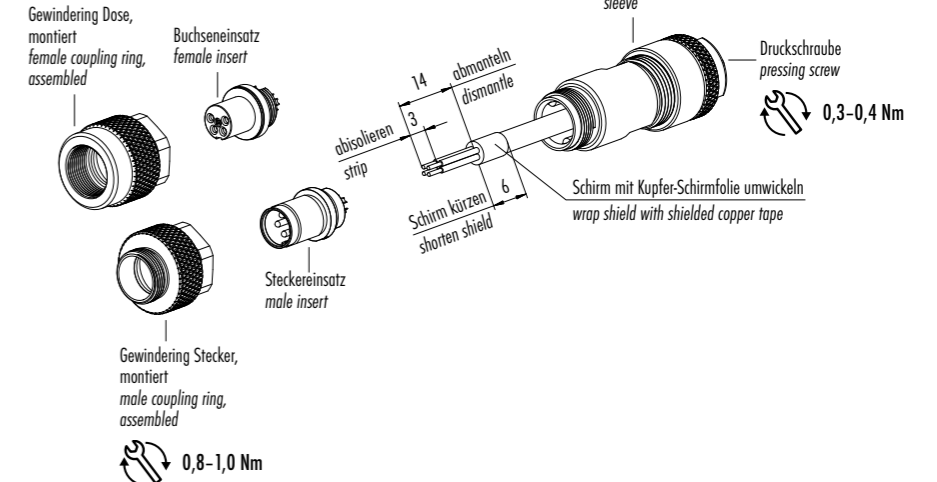

Montageanleitung
Assembly instruction

Gewinkelte Kunststoffausführung
Angled plastic version

1. Teile auf Kabel auffädeln.
2. Abmanteln auf L = 12 mm.
3. Litzen abisolieren (L = 3 mm).
4. Litzen durch Gehäuse fädeln. Dichtring und Klemmkorb montieren, Druckschraube andrehen.
5. Litzen anlöten.
6. Gehäuse mit Kontakteinsatz verschrauben und Druckschraube festdrehen.

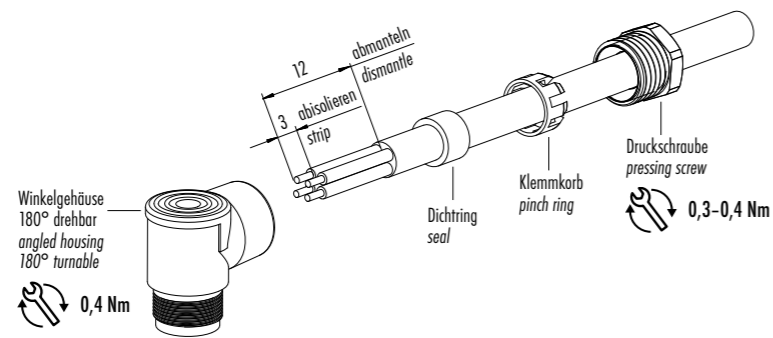

1. Bead parts to cable.
2. Dismantle cable to 12 mm length.
3. Strip single wires (L = 3 mm).
4. Bead single wires through housing. Mount seal and pinch ring, turn on pressing screw.
5. Solder single wires.
6. Screw housing to contact insert and tighten pressing screw.

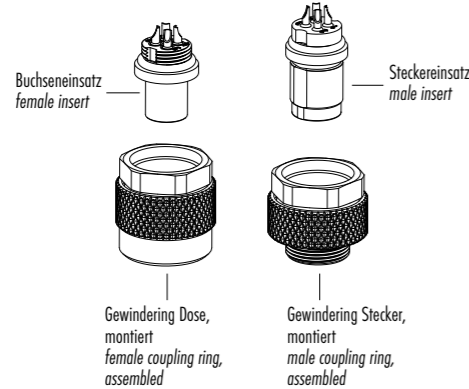

Gewinkelte Metallausführung, EMV
Angled metal version, EMI

1. Teile auf Kabel auffädeln.
2. Abmanteln auf L = 25 mm.
3. Litzen abisolieren (L = 3 mm), Schirm aufweiten und um Schirmring legen.
4. Litzen durch Gehäuse fädeln. Schirmring, Dichtring und Klemmkorb montieren. Druckschraube andrehen, um das Kabel zu fixieren.
5. Litzen anlöten.
6. Gehäuse mit Kontakteinsatz verschrauben und Druckschraube festdrehen.
7. Verschlusschraube anziehen.

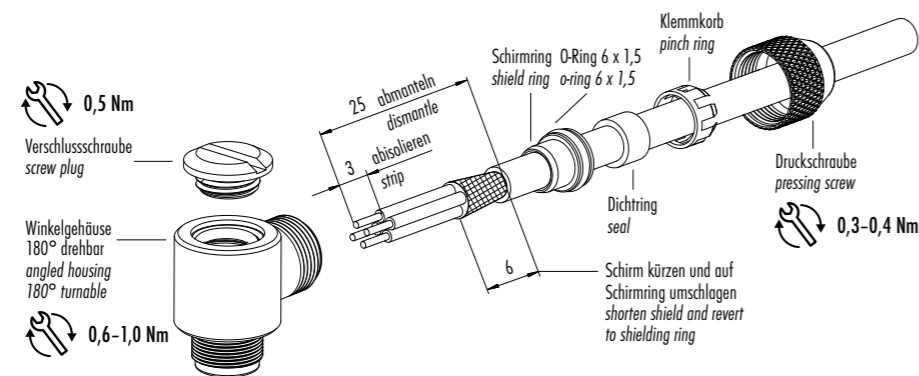

1. Bead parts to cable.
2. Dismantle cable to 25 mm length.
3. Strip single wires (L = 3 mm), widen shield and revert to shielding ring.
4. Bead single wires through housing. Mount shielding ring, seal and pinch ring. Turn on pressing screw to fix the cable.
5. Solder single wires.
6. Screw housing to contact insert and tighten pressing screw.
7. Tighten screw plug.

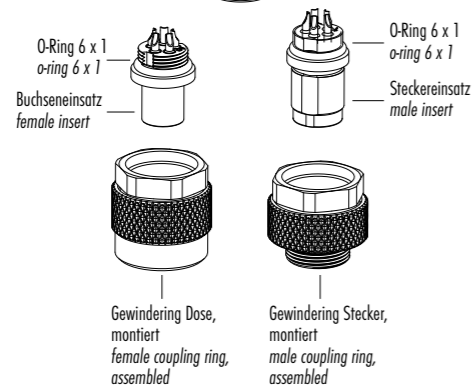

Einzelteildarstellung
Component part drawing

Flanschsteckverbinder, löten
Panel mount connectors, solder

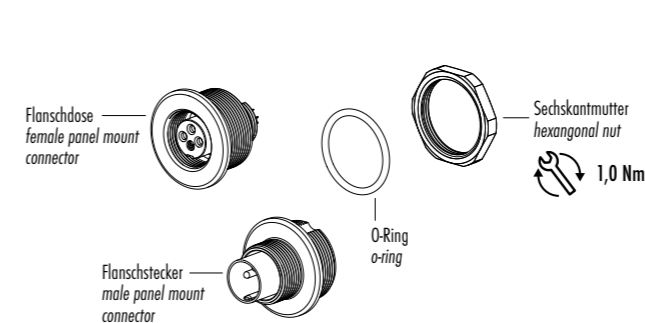

Flanschsteckverbinder, löten, von vorn verschraubbar
Panel mount connectors, solder, dip solder, front fastened

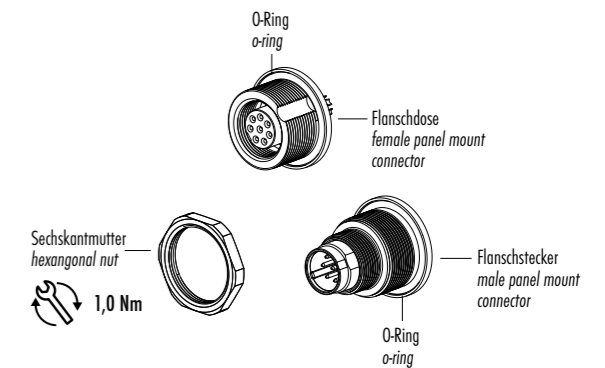

Flanschsteckverbinder, tauchlöten, von vorn verschraubbar
Panel mount connectors, dip solder, front fastened

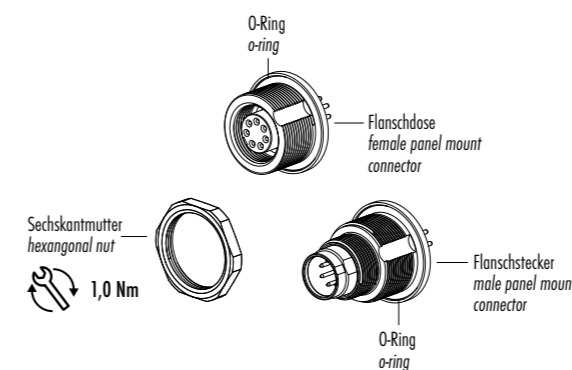

Flanschsteckverbinder, tauchlöten, von vorn verschraubbar, mit Schirmblech
Panel mount connectors, dip solder, front fastened, with shielding sheet

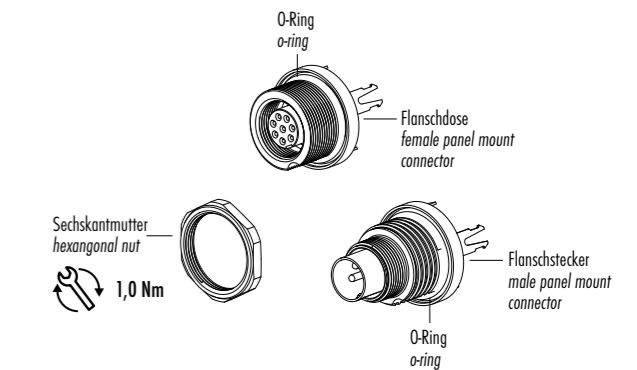

Polbilder
Contact arrangements

Stifteinsatz (Steckseite)
Male insert (mating side)

Buchseinsatz (Steckseite)
Female insert (mating side)

2 pol
2 contacts

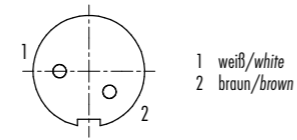
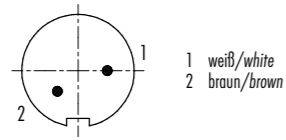

3 pol
3 contacts

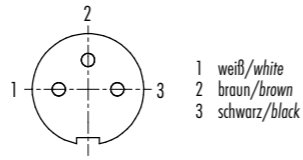
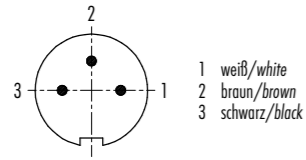

4 pol
4 contacts

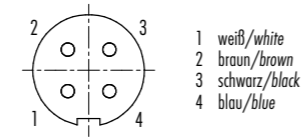
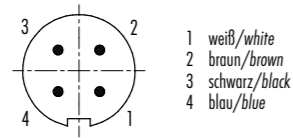

5 pol
5 contacts

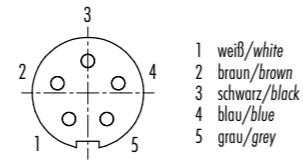
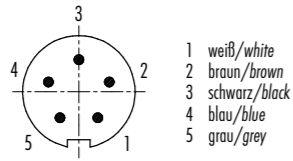

7 pol
7 contacts

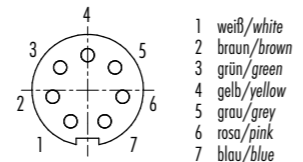
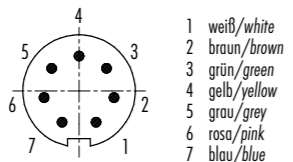

8 pol
8 contacts

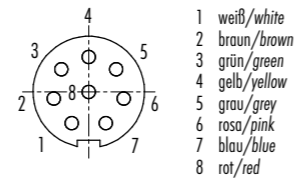
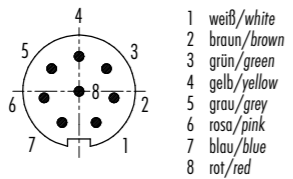

Montageausschnitt
Panel cut out

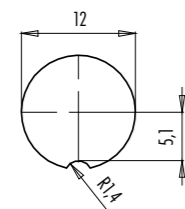

Bohrbilder Stifteinsatz (Leiterplatte), Schirmblechvariante
Drilling schemes male insert (PCB), shielding sheet

Bohrbilder Buchseinsatz (Leiterplatte), Schirmblechvariante
Drilling schemes female insert (PCB), shielding sheet

2 pol
2 contacts

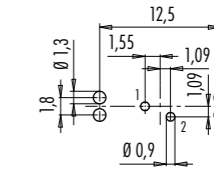
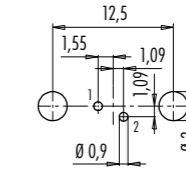
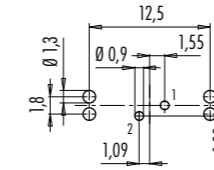
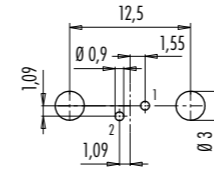

Winkelversion
Angled version

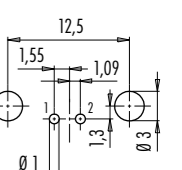

3 pol
3 contacts

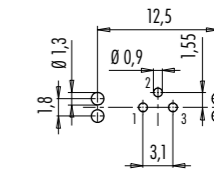
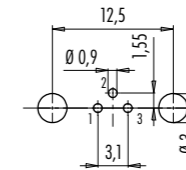
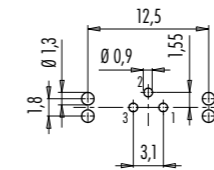
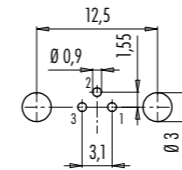

4 pol
4 contacts

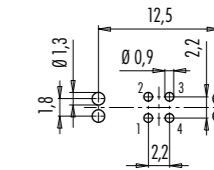
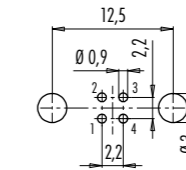
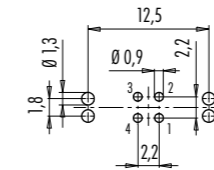
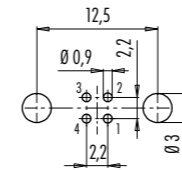

5 pol
5 contacts

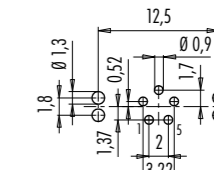
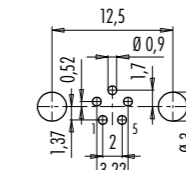
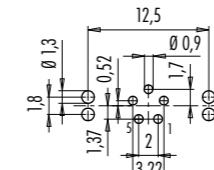
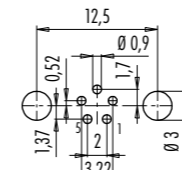

Winkelversion
Angled version

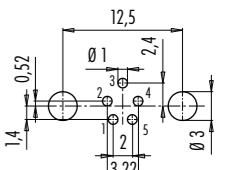

7 pol
7 contacts

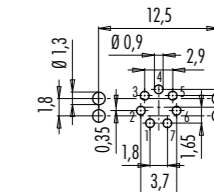
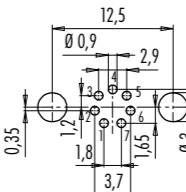
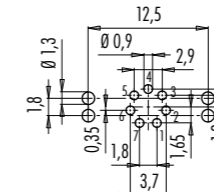
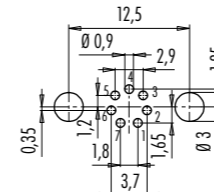

8 pol
8 contacts

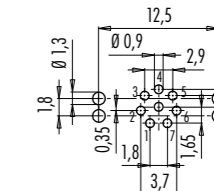
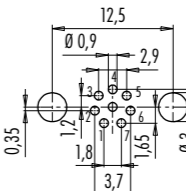
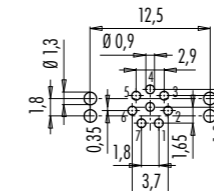
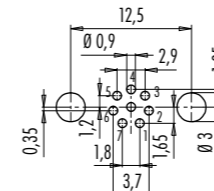

Zeichnungen
Drawings

09 0423 65 07

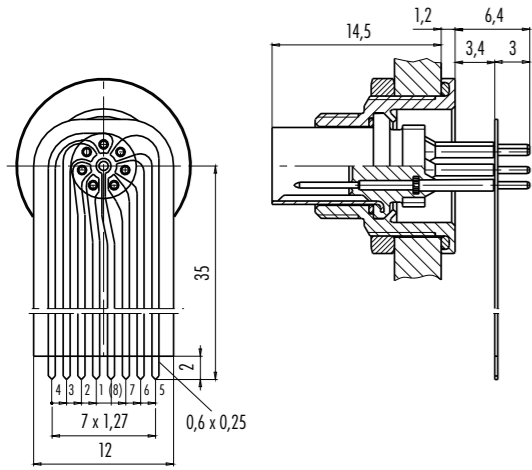

09 0424 65 07

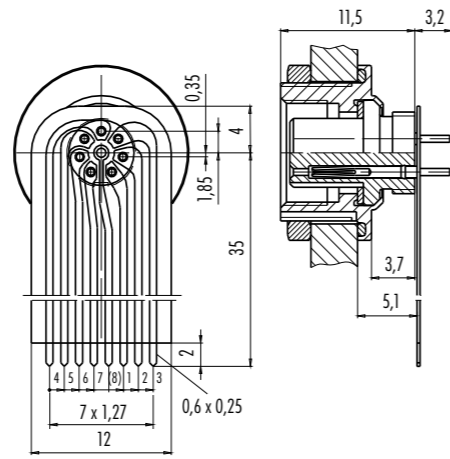

09 0427 65 08

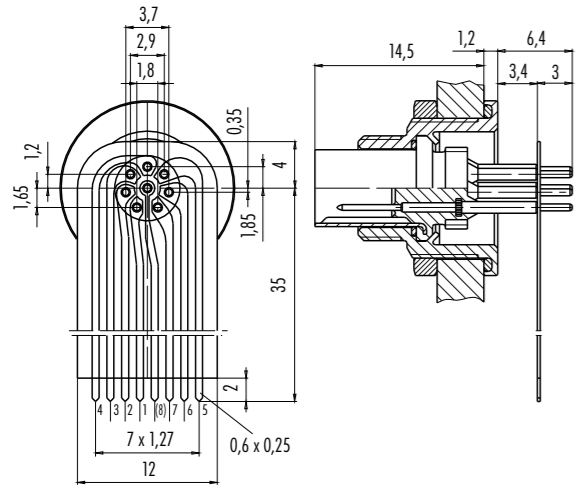

09 0428 65 08

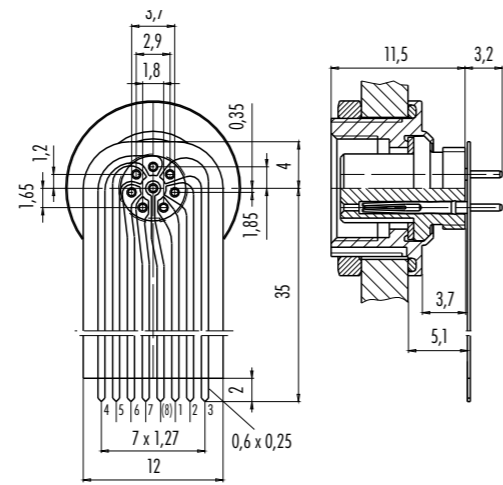

Bezeichnung / Description

Maßzeichnung / Drawing

Bestell-Nr. / Ordering-No.

Schutzkappe für Kabelstecker
Protection cap for male cable connector

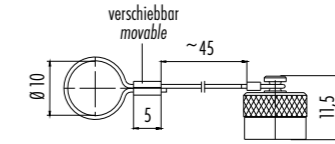

08 0349 000 001

Schutzkappe für Kabeldose
Protection cap for female cable connector

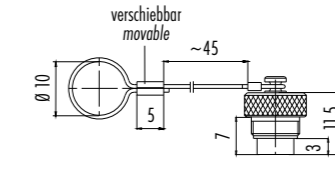

08 0350 000 001

Schutzkappe für Flanschstecker
Protection cap for male panel mount connector

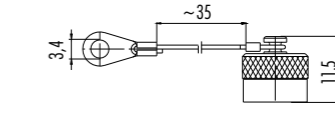

08 0351 000 001

Schutzkappe für Flanschdose
Protection cap for female panel mount connector

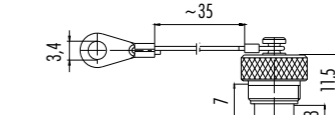

08 0352 000 001

Viereckflansch mit Dichtung
Square flange with seal

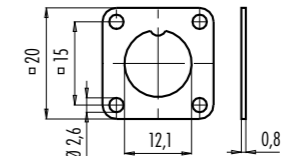
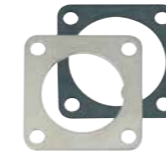

08 1124 000 001

Lötösenring
Solder eye ring

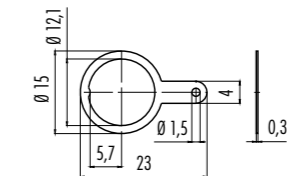

04 0208 002

Sechskantmutter mit Rändel 2 mm
Knurled hexagon nut 2 mm

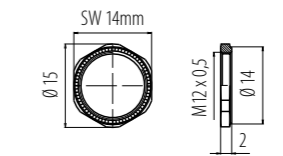

01 0013 001

Montageschlüssel
Mounting spanner

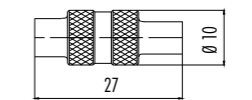

01 5059 001

Adapter Schaltschrank-
durchführung
Adapter lead-through
for control cabinet

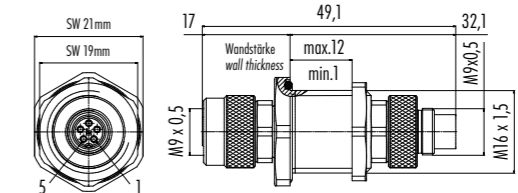

09 9618 100 05





„Für unsere Kunden entwickeln wir individuelle Rundsteckverbinder in der Automatisierungs-, Industrie- und Medizinbranche.“

Zitat Markus Binder



“For our customers we develop individual circular connectors in the automation, industrial and medical field.”

Quote Markus Binder





**Franz Binder GmbH & Co.
Elektrische Bauelemente KG**

Rötelstraße 27
74172 Neckarsulm
Deutschland / Germany

Tel. +49 7132 325-0
Fax +49 7132 325-190

vk@binder-connector.de
www.binder-connector.com

04/2024

